



## Installation and Operation Manual



## IC-100 CD Ignition System

Manual 26205 (Revision B)

## IMPORTANT



This is the safety alert symbol. It is used to alert you to potential personal injury hazards. Obey all safety messages that follow this symbol to avoid possible injury or death.

## DEFINITIONS

- **DANGER**—Indicates a hazardous situation which, if not avoided, will result in death or serious injury.
- **WARNING**—Indicates a hazardous situation which, if not avoided, could result in death or serious injury.
- **CAUTION**—Indicates a hazardous situation which, if not avoided, could result in minor or moderate injury.
- **NOTICE**—Indicates a hazard that could result in property damage only (including damage to the control).
- **IMPORTANT**—Designates an operating tip or maintenance suggestion.

## WARNING

The engine, turbine, or other type of prime mover should be equipped with an overspeed shutdown device to protect against runaway or damage to the prime mover with possible personal injury, loss of life, or property damage.

The overspeed shutdown device must be totally independent of the prime mover control system. An overtemperature or overpressure shutdown device may also be needed for safety, as appropriate.



Read this entire manual and all other publications pertaining to the work to be performed before installing, operating, or servicing this equipment. Practice all plant and safety instructions and precautions. Failure to follow instructions can cause personal injury and/or property damage.



This publication may have been revised or updated since this copy was produced. To verify that you have the latest revision, be sure to check the Woodward website:

[www.woodward.com/pubs/current.pdf](http://www.woodward.com/pubs/current.pdf)

The revision level is shown at the bottom of the front cover after the publication number. The latest version of most publications is available at:

[www.woodward.com/publications](http://www.woodward.com/publications)

If your publication is not there, please contact your customer service representative to get the latest copy.



Any unauthorized modifications to or use of this equipment outside its specified mechanical, electrical, or other operating limits may cause personal injury and/or property damage, including damage to the equipment. Any such unauthorized modifications: (i) constitute "misuse" and/or "negligence" within the meaning of the product warranty thereby excluding warranty coverage for any resulting damage, and (ii) invalidate product certifications or listings.

## NOTICE

To prevent damage to a control system that uses an alternator or battery-charging device, make sure the charging device is turned off before disconnecting the battery from the system.

## NOTICE

To prevent damage to electronic components caused by improper handling, read and observe the precautions in Woodward manual 82715, *Guide for Handling and Protection of Electronic Controls, Printed Circuit Boards, and Modules*.

Revisions—Text changes are indicated by a black line alongside the text.

Woodward Governor Company reserves the right to update any portion of this publication at any time. Information provided by Woodward Governor Company is believed to be correct and reliable. However, no responsibility is assumed by Woodward Governor Company unless otherwise expressly undertaken.

© Woodward 2003  
All Rights Reserved

# Contents

<b>ELECTROSTATIC DISCHARGE AWARENESS .....</b>	<b>III</b>
<b>CHAPTER 1. GENERAL INFORMATION.....</b>	<b>1</b>
Introduction .....	1
Operational Features .....	1
Limitations .....	1
<b>CHAPTER 2. IC-100 IGNITION SYSTEM INSTALLATION .....</b>	<b>3</b>
Unpacking.....	3
Safety.....	3
Installation .....	4
Setting the Ignition Timing Adjustment Range and Positioning the Trigger Disc.....	12
Disposal of the Ignition Control System .....	14
Wiring Requirements .....	14
<b>CHAPTER 3. OPERATION .....</b>	<b>23</b>
Programming the IC-100 with a Laptop.....	23
Programming the IC-100 with the Hand Held Programmer .....	23
IC-100 Programming Overview .....	24
Additional Functions .....	37
Initial Start-up Procedure.....	38
<b>CHAPTER 4. MAINTENANCE AND TROUBLESHOOTING.....</b>	<b>40</b>
Maintenance .....	40
Faults and Troubleshooting .....	40
<b>CHAPTER 5. SERVICE OPTIONS .....</b>	<b>45</b>
Product Service Options.....	45
Woodward Factory Servicing Options .....	46
Returning Equipment for Repair.....	46
Replacement Parts .....	47
Engineering Services.....	47
How to Contact Woodward.....	48
Technical Assistance .....	48
<b>APPENDIX. PROGRAMMING OVERVIEW.....</b>	<b>49</b>
<b>DECLARATIONS.....</b>	<b>52</b>
<b>IC-100 CONTROL SPECIFICATIONS .....</b>	<b>53</b>

## Illustrations and Tables

Figure 2-1. IC-100 Outline Drawing.....	6
Figure 2-2. Trigger Disc Mechanical Requirements.....	7
Figure 2-3. Mounting of Camshaft Trigger Disc.....	8
Figure 2-4. Mounting a Trigger Disc with Slots.....	10
Figure 2-5. Mounting of Flywheel Pickup.....	12
Figure 2-6. Example of Positioning of Flywheel.....	13
Figure 2-7. IC-100 Wiring Diagram.....	16
Figure 2-8. 0–5 Volt Retarded Curve.....	17
Figure 2-9. 0–5 Volt Advanced Curve.....	18
Figure 2-10. Two-point Adjustment.....	18
Figure 2-11. Potentiometer Setting.....	19
Figure 2-12. GO/NOGO Output.....	19
Figure 4-1. Oscilloscope—Square Wave Signal.....	42
Table 2-1. Input Wiring with Passive Pickup.....	20
Table 2-2. Input Wiring with Active Pickup.....	21
Table 2-3. Cylinder Output Pin-out.....	21
Table 2-4. Ignition Firing Order.....	22
Table 4-1. LED Flash Codes.....	40

## Electrostatic Discharge Awareness

All electronic equipment is static-sensitive, some components more than others. To protect these components from static damage, you must take special precautions to minimize or eliminate electrostatic discharges.

Follow these precautions when working with or near the control.

1. Before doing maintenance on the electronic control, discharge the static electricity on your body to ground by touching and holding a grounded metal object (pipes, cabinets, equipment, etc.).
2. Avoid the build-up of static electricity on your body by not wearing clothing made of synthetic materials. Wear cotton or cotton-blend materials as much as possible because these do not store static electric charges as much as synthetics.
3. Keep plastic, vinyl, and Styrofoam materials (such as plastic or Styrofoam cups, cup holders, cigarette packages, cellophane wrappers, vinyl books or folders, plastic bottles, and plastic ash trays) away from the control, the modules, and the work area as much as possible.
4. Do not remove the printed circuit board (PCB) from the control cabinet unless absolutely necessary. If you must remove the PCB from the control cabinet, follow these precautions:
  - Do not touch any part of the PCB except the edges.
  - Do not touch the electrical conductors, the connectors, or the components with conductive devices or with your hands.
  - When replacing a PCB, keep the new PCB in the plastic antistatic protective bag it comes in until you are ready to install it. Immediately after removing the old PCB from the control cabinet, place it in the antistatic protective bag.

### **NOTICE**

To prevent damage to electronic components caused by improper handling, read and observe the precautions in Woodward manual 82715, *Guide for Handling and Protection of Electronic Controls, Printed Circuit Boards, and Modules*.



# Chapter 1.

## General Information

### Introduction

The IC-100 is a microprocessor-controlled, capacitive spark discharge ignition system capable of supplying ignition energy for certain two- or four-stroke gas engines with one to eight cylinders (single-firing) or two to 16 cylinders (double firing).

The number of cylinders and the corresponding firing pattern, as well as the trigger disc configuration, are programmed individually.

Integral to the IC-100 is one adjustment potentiometer. This has a programmable maximum span of 38°. Additional methods of adjustment are by means of an integral speed curve and a linear 0–5 V analog signal. A two-stage adjustment is also possible with the aid of the analog signal and the use of an external potentiometer.

The IC-100 is capable of firing up to eight cylinders with either one or two spark plugs per cylinder. In the case of two spark plugs per cylinder, the corresponding ignition coils must be wired in series.

A cam or crankshaft trigger disc is used to provide relative position reference. This information is sent to a microprocessor that controls the ignition system. Thus, the system is alerted whenever a new cycle has begun.

The IC-100 is intended for use in non-hazardous locations.

### Operational Features

In order to ensure perfect operation of the ignition control system, observe the maintenance instructions given in Chapter 4.

The IC-100 has several functional features to ensure proper operation:

- trigger signal check
- input signal fault recognition
- shutdown
- manual ignition timing adjustment

### Limitations

The IC-100 ignition control system provides ignition energy for one to eight or two to 16-cylinder gas engines. Trigger disc configurations are listed in Chapter 2.

The IC-100 is intended only for use on the engines listed in the configuration table (see Chapter 3). It also needs to be programmed to comply with the appropriate engine.

The IC-100 is designed for continuous operation in conditions of a still air environment with a maximum ambient temperature of 55 °C (which corresponds to a 70 °C maximum case temperature). Certain applications and operating conditions may require cooling the IC-100 to ensure long-term reliable operation. The interval between plug firings is the primary factor in determining the maximum allowed ambient temperature. Firing interval is determined by the following formula:

$$time[ms] = \frac{S * 30000 * D}{RPM * C}$$

where:

S=2 for a two-stroke engine

S=4 for a four-stroke engine

D=1 for single firing engines (typical)

D=2 for double firing engines (two cylinders fired at once)

C is the number of cylinders

RPM is the crankshaft steady state engine speed

At firing intervals less than 8.33 milliseconds, check the case temperature of the IC-100. The temperature should be measured at the far end of the box, which is opposite the side with the connectors. If it exceeds 70 °C, some means of reducing the case temperature is required. Forced air-flow or mounting to a heat sink can accomplish this. Temperature should be measured for two hours to ensure that thermal stability is achieved before taking a measurement.



## Chapter 2.

# IC-100 Ignition System Installation

### Unpacking

Check the shipping container for evidence of mishandling during shipping. Carefully remove the IC-100 from the shipping container. Check the hardware for evidence of damage during shipping. Notify the shipper and Woodward if shipping damage is found.

### Safety

The operator of the equipment must ensure:

- That all persons concerned with the installation, maintenance, and repair of the IC-100 ignition control system have entirely read and completely understood this operating manual.
- That all persons authorized to operate the gas engine have received detailed instruction and have been warned about possible dangers.



**In no case should the following parts of the ignition control system be touched, removed, or disconnected while the engine is running:**

- **ignition coils and caps**
- **high tension leads**
- **low voltage circuit leads**
- **harness connectors**

The IC-100 ignition control system design conforms to high technology principles and is operationally safe. The equipment may suffer damage or pose the threat of injury if the following safety precautions are not observed. Only trained and authorized personnel must operate the gas engine.

- Before commencing any work involving the installation, operation, resetting, matching, maintenance, or repair of the ignition control system, the equipment must be disconnected from the power supply and safeguarded against switching on the power.
- The harness must be removed.
- Safety devices must not be disassembled or inactivated.
- Avoid all work that might impair the function of the ignition control system.
- Only operate the ignition control system provided it is in perfect condition, and inform all concerned personnel of any modifications which have been made to the gas engine or the ignition control system.
- Ensure that you observe all the rules and regulations pertaining to your equipment, including those that are not explicitly stated here.
- Always ensure that the engine room is properly ventilated!

- Ensure that you maintain a safe distance from the gas engine and the ignition control system.

**WARNING**

Switch off the engine; disconnect the power supply, and lock out both before commencing any installation work.

**WARNING**

Make sure that the system was programmed for your engine before attempting to operate the IC-100 ignition system. An improperly installed or programmed system may lead to engine damage and could pose threat of personal injury to operators.

## Installation

**NOTICE**

Read this section carefully before assembling the components!

A complete ignition system consists of:

- The IC-100 ignition control module
- Ignition coils (one per cylinder minimum)
- Protection cap for ignition coil, high tension side
- Protection cap for ignition coil, low tension side
- Input/output harness
- A speed pickup for the flywheel trigger disc or an active pickup for the camshaft trigger disc
- A trigger disc
- High tension leads, customized

Before commencing with the final assembly, it is advisable to carefully consider the mounting locations of the individual components. A good choice of mounting locations ensures proper operation of the entire ignition system.

### Ignition Control Module

Considerations for IC-100 mounting location:

- Specified environmental limits
  - Temperature
  - Vibration
- Cable length to
  - Power supply
  - Pickup units
  - The distance between the ignition control module and the pickup unit should not exceed 6 m (20 ft).
- Away from high voltage or high current devices or high electromagnetic radiation (EMC) sources
- Clearance for cables

**NOTICE**

Never do any welding work on the engine or chassis when the ignition control module is mounted on the engine or connected to the chassis. This could destroy the ignition control module!

- Mount the ignition control module in such a way that the cable harness may be easily routed downwards.
- Mount the ignition control module on a secure bracket near the engine using vibration-damping mounts.
- The ignition control module **must be** grounded to the engine through the mounting hardware or a very short strap (25x76 mm/1x3" braid).
- The ignition control module should be mounted in the cooling fan air-stream if practical.

**NOTICE**

Mount the IC-100 using the bolt pattern shown in Figure 2-1. Do not mount the IC-100 directly on the engine. The IC-100 must be mounted in an off-engine location, avoiding excessive vibration and heat.

### Trigger Disc

Depending on the engine design, there are two possibilities to trigger the ignition:

- Trigger disc mounted on **crankshaft**. This location is required for 2-stroke engines (double firing on 4-stroke engines; ignition fires on compression and exhaust stroke). The magnetic disc is equipped with a certain number of holes, slots, or magnets. This disc may use a **passive** or **active pickup** unit.
- Trigger disc mounted on **camshaft**. This location is recommended for 4-stroke engines (single firing, ignition fires on compression stroke only). The non-magnetic disc is equipped with a specified number of magnets or holes. Using a disc with holes or pins for the camshaft requires an **active pickup** unit.

The crankshaft and camshaft pickup should be mounted at a convenient position providing easy access for maintenance.

A massive and vibration-free bracket must be prepared for mounting the pickup.

### 2-Stroke and Double-Firing 4-Stroke Engines

Mount the trigger disc on the flywheel, pulley disc, or vibration damper. The trigger disc must rotate at crankshaft speed.

**NOTICE**

Ensure that the trigger disc is perfectly centered!

Instead of using a disc, holes can be drilled into the flywheel. For the basic setting, outlined in Figure 2-6, the hole, slot or pin "A" has to be opposite the pickup mounting hole.

For engine timing see "Setting the Ignition Timing Adjustment Range" later in this chapter.

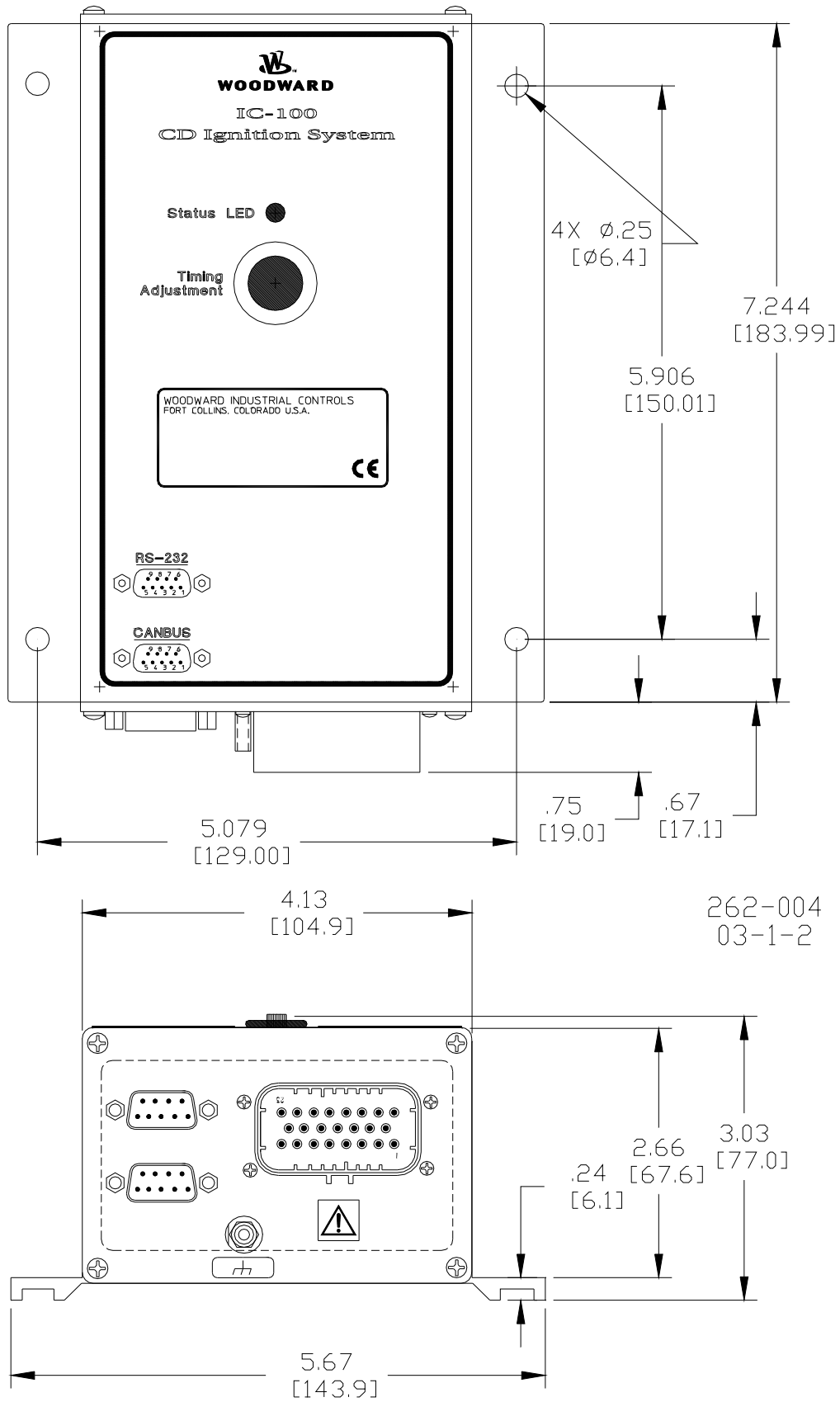

Figure 2-1. IC-100 Outline Drawing

**Single-Firing 4-Stroke Engines**

Mount the trigger disc on the camshaft or any drive running at one-half engine speed.

NOTICE

**Ensure that the trigger disc is perfectly centered!**

For the basic setting outlined in Figure 2-6, the hole, slot, or pin “A” has to be opposite the pickup mounting hole.

For engine timing see “Setting the Ignition Timing Adjustment Range” later in this chapter.

- NOTES:  
 1. NOTE DIRECTION OF ROTATION.  
 2. INCH [MM] AS SPECIFIED.

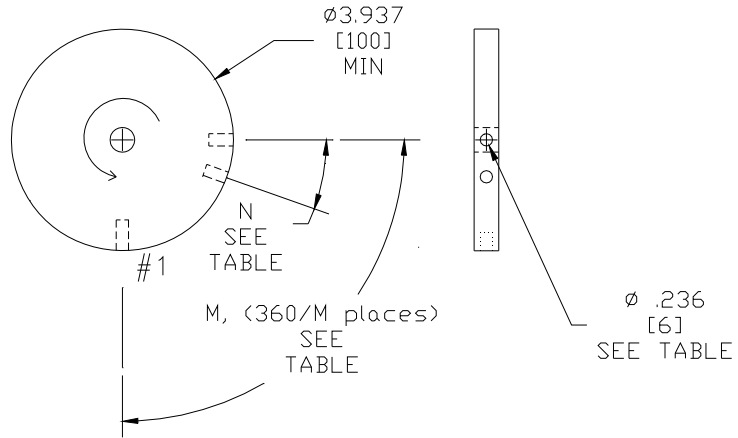

CONFIGURATION	N (DEGREES)	M (DEGREES)	HOLES
2+1	20	180	3
3+1	20	120	4
4+1	20	90	5
5+1	20	72	6
6+1	20	60	7
7+1	20	51.42	8
8+1	15	45	9

262-024  
03-1-2

Figure 2-2. Trigger Disc Mechanical Requirements

## Camshaft Pickup

The camshaft pickup generates a square wave signal.

### NOTICE

It is essential to take account of the camshaft slope in order to prevent the reluctor pin from striking the pickup!

### NOTICE

In order to avoid defective signals, the mounting surface must be free of sharp edges, holes, or other irregularities.

### Preparations for Active Pickup

- Prepare a massive and vibration-free mount for the active pickup unit.
- The bracket must be positioned in such a way that the pickup is directed at a right angle to the surface of the disc.
- Drill and tap a hole to accept the chosen pickup.

### NOTICE

Ensure that metal chips, filings, or shavings from drilling and tapping operations do not remain in the engine!

Example: 4-cylinder-engine  
trigger disc with reluctor pins  
(4+1 configuration)

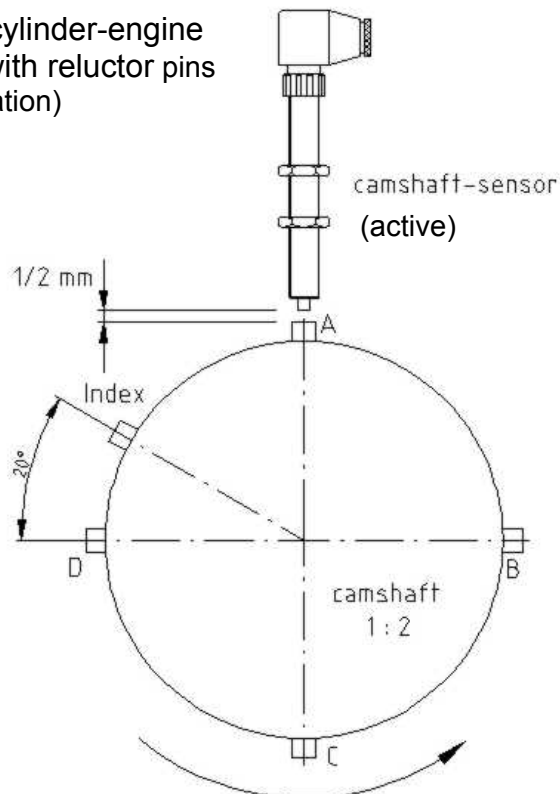
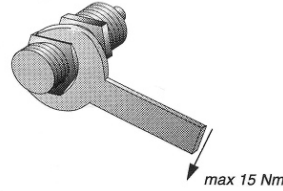

Figure 2-3. Mounting of Camshaft Trigger Disc

## Installation of a Disc with Reluctor Pins

### IMPORTANT

Tightening torque for the camshaft pickup: max. 15 N·m (11 lb-ft)!



In order to avoid defective signals, the mounting surface must be free of sharp edges, holes, or other irregularities.

### WARNING

Take care to ensure that the speed pickup unit does not rotate with the lock nut, thereby causing the gap to alter.

It is essential that the threaded hole be perpendicular to the surface of the ring gear!

- Screw the active pickup into the tapped hole.
- The pickup must point to the "A" reluctor pin at a right angle.
- The air gap between the tip of the reluctor pin and the surface of the pickup should be approximately 0.5 mm (0.02 inch).
- This gap is best achieved by following these steps:
  - screw in the pickup until it just makes contacts with the tip of the reluctor pin;
  - unscrew the pickup by a half turn counterclockwise direction.
- Now tighten the lock nut, taking care to ensure that the pickup does not rotate at the same time.
- Crank the engine back and forth several times by a few degrees to make sure that the reluctor pin does not strike the pickup surface.

## Mounting a Trigger Disc with Slots

### IMPORTANT

Tightening torque for active pickup: max. 15 N·m (11 lb-ft)!

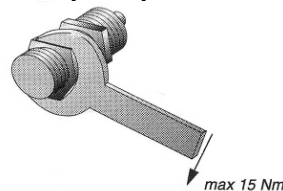

Example 6-cylinder-engine  
trigger disc with slots  
(6+1 configuration)

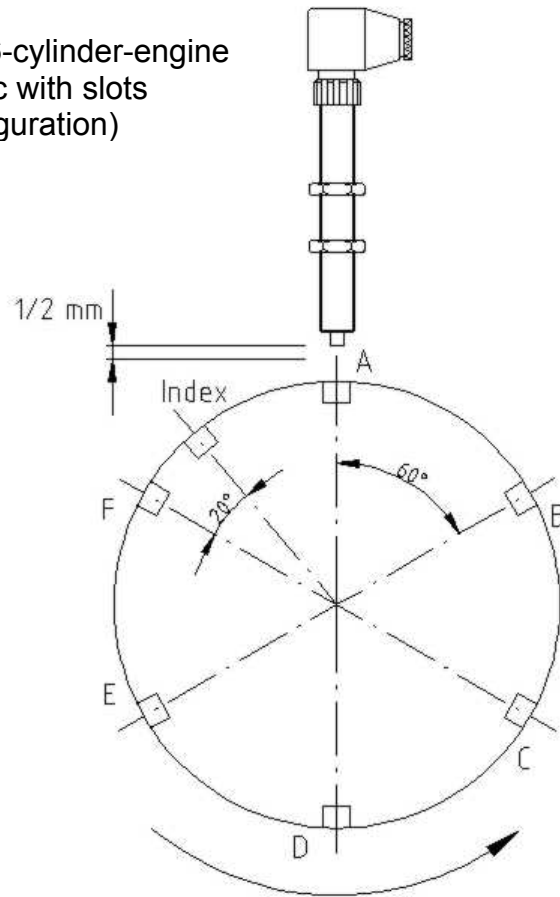

Figure 2-4. Mounting a Trigger Disc with Slots

## NOTICE

In order to avoid defective signals, the mounting surface must be free of sharp edges, holes, or other irregularities.

## NOTICE

It is essential that the threaded hole is perpendicular to the surface of the ring gear!



## WARNING

Take care to ensure that the speed pickup does not rotate with the lock nut, thereby causing the gap to alter.

- Screw the speed pickup into the tapped hole.
- The pickup must point to the "A" reluctor pin at right angles.
- The air gap between the surface of the trigger disc and the surface of the pickup should be approximately 0.5 mm (0.02 inch).
- This gap is best achieved by following these steps:
  - screw in the pickup until it just makes contact with the surface of the trigger disc;
  - unscrew the pickup by ½ turn counterclockwise direction.



- Now tighten the lock nut, taking care to ensure that the pickup does not rotate at the same time.
- Crank the engine back and forth several times by a few degrees to make sure that the pickup does not strike the trigger disc.

## Flywheel Pickup

The flywheel pickup senses an ac signal if a passive pickup is used.

## Mounting Location

A massive and vibration-free bracket must be prepared for the speed pickup.

## Preparations

- Drill and tap a hole to accept the magnetic pickup. This hole must be drilled in such a way that the pickup is directed towards the surface of the trigger disc at right angle.

### **NOTICE**

Ensure that metal chips, filings, or shavings from drilling and tapping operations do not remain in the engine!

### **WARNING**

It is essential that the threaded hole be perpendicular to the surface of the ring gear!

## Installation

- Screw the pickup into the threaded hole. The pickup must be precisely directed towards the center of the flywheel. The gap between its surface and the surface of the trigger disc must be approximately 0.6 mm (0.02 inch). This gap is best achieved by screwing in the pickup unit until it just makes contact with the top of the trigger disc or flywheel, then unscrewing it one-half turn counterclockwise.
- Fix the pickup in place by means of the lock nut.
- Slowly crank the engine a full rotation to ensure that the disc does not strike the pickup.

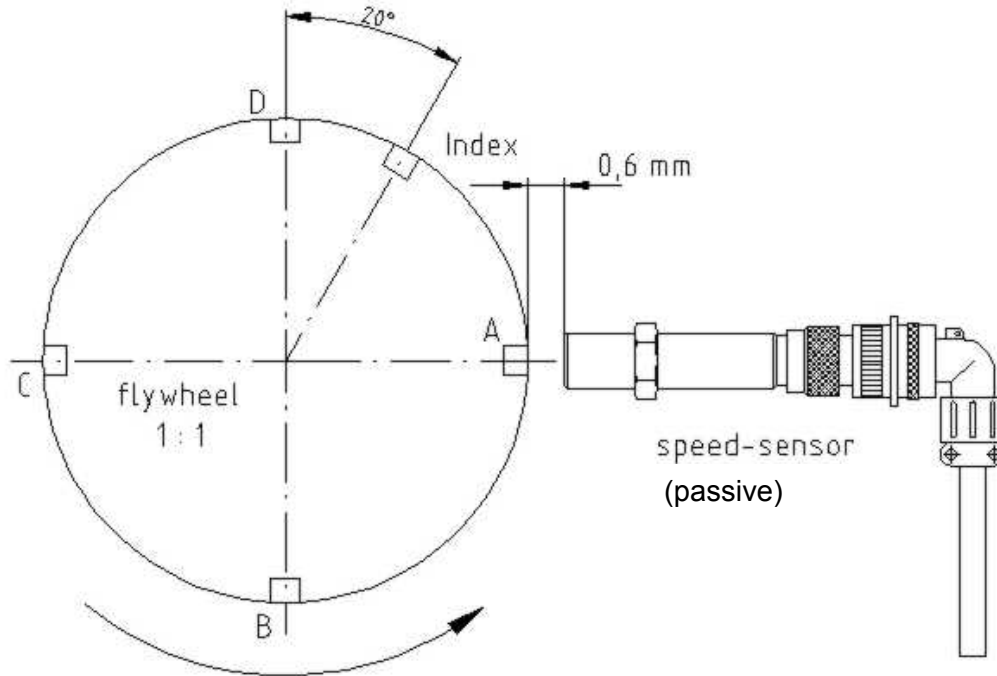

## Setting the Ignition Timing Adjustment Range and Positioning the Trigger Disc

The maximum ignition timing range of the IC-100 ignition control module is 38 degrees. The minimum ignition timing range is 23 degrees. The maximum range is achieved with a base setting of 40° BTDC or more. Lower base settings reduce the ignition timing range.

The **base setting** is the crank angle of cylinder #1, on the compression stroke, when the trigger disc "A" pin is aligned with the pickup. Typically the base setting target is the most advanced ignition timing the engine needs plus 2 or more degrees. The IC-100 ignition control module requires 2 degrees for computation time.

To obtain the correct base setting:

1. Bar the engine over until cylinder #1 is on the compression stroke and at the correct crank angle for the base setting.
2. Rotate the trigger disc on the camshaft or crankshaft to align pin "A" with the pickup.
3. Securely fasten the trigger disc to the camshaft or crankshaft.
4. Setting must be between 25° and 60° BTDC on cylinder #1. Be sure the range fits the engine ignition timing requirements.

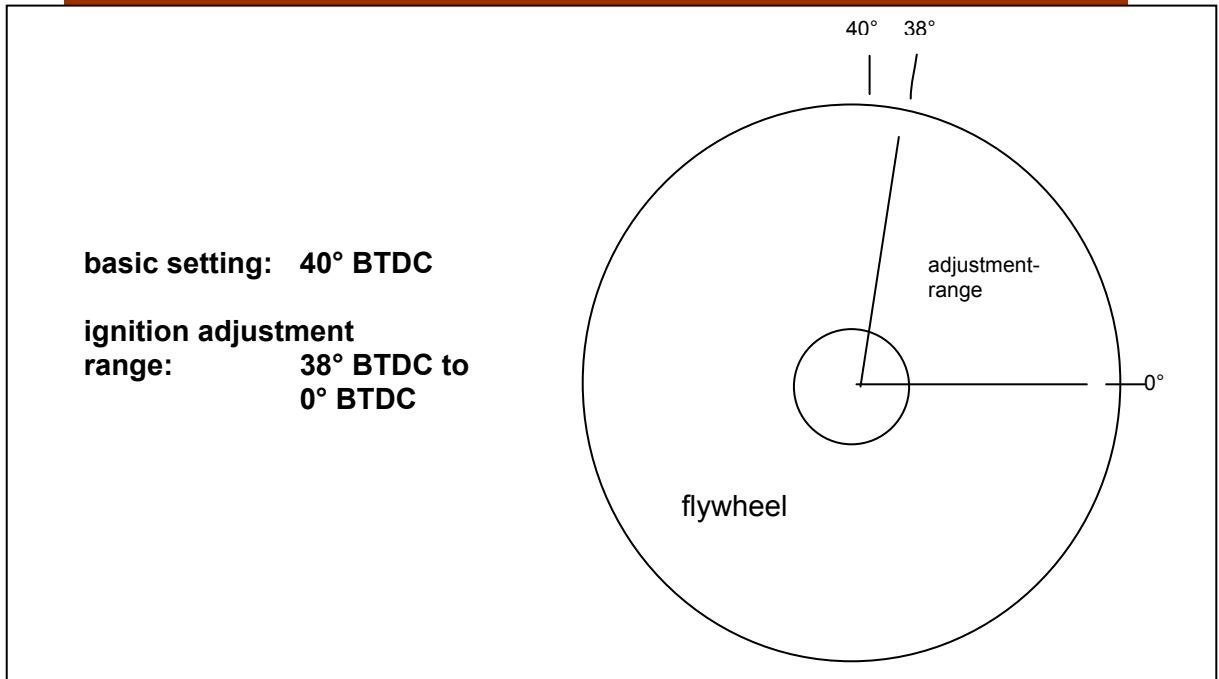
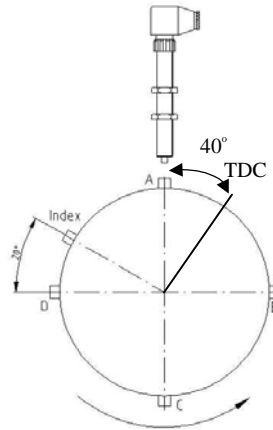

Figure 2-6. Example of Positioning of Flywheel

**NOTICE**

Ensure that the trigger disc is perfectly centered!



The maximum advance for the ignition timing (° BTDC) is the base setting minus a 2 degree computation time. Maximum advance is limited to 58° BTDC. Maximum retard is limited to 0.0° BTDC.

**Example A:**

Basic setting: 40° BTDC

Ignition adjustment range: 38° BTDC to 0° BTDC ( $\Delta$  38°)

**Example B:**

Basic setting: 30° BTDC

Ignition adjustment range: 28° BTDC to 0° BTDC ( $\Delta$  28°)

**Example C:**

Basic setting: 50° BTDC

Ignition adjustment range: 48° BTDC to 10° BTDC (... 38°)

**IMPORTANT**

The system does not allow After Top Dead Center (ATDC) ignition timing.

## Disposal of the Ignition Control System

The IC-100 is comprised of only a small amount of surplus refuse that may be disposed of in the usual manner as industrial waste.

## Wiring Requirements

### General



This symbol identifies earth ground. It is to be used to connect the IC-100 to earth ground.

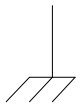

This symbol identifies chassis ground. This terminal is to be used for cable shield or for connecting the cable gland plates to the chassis.

To maintain compliance with CE marking requirements, the EMC directive requires that all shields be connected to the terminals provided in the IC-100 according to the wiring diagram as in Figure 2-7. In addition, the IC-100 must be connected to earth ground (engine) through the mounting hardware or a very short strap (25x76 mm/1x3" braid).

**IMPORTANT**

Wire exposed beyond the shield must be as short as possible.

## IC-100 CD Ignition System Electrical Connections and Pin Functionality

**WARNING**

The engine power supply must be disconnected and safeguarded against switching on before beginning any work on the IC-100. Do not make any power supply connections into live power circuits!

Never switch on the ignition control module without the output leads connected to the unit.

An improperly installed ignition system may lead to engine damage and could pose threat of personal injury to operators.

All components (ignition control module, ignition coils, and all lead screens) must be grounded to ensure electromagnetic compatibility.

**NOTICE**

Take care to ensure that the following minimum and maximum voltages to the IC-100 are complied with:

- Minimum 10 Vdc
- Maximum 32 Vdc

Input voltages beyond these values might damage the IC-100.

**IMPORTANT**

Shutdown of the IC-100 is achieved by switching off the input power. Emergency shutdown devices must be rewired in order to switch off the input power.

The IC-100 CD ignition system offers the option of RS-232 or CANBus communication. All input power, various I/O, and ignition coil output connection are made through a 23 socket-pin plug connector.

### RS-232 Port

The IC-100 may programmed via RS-232 using a null modem cable. Any fault indications will be transmitted to a PC/laptop through the RS-232 link.

### CANBus

There are two modes for the CANBus: display (read only) and control (read/write). The write mode is enabled with the RS-232 programming mode "CAN BUS ENABLED". For instructions on how to operate in this mode, please contact the factory (see chapter 5 for instructions). With both modes, once the CANBus has active communication, the ESC key on the RS-232 does not work. This is to prevent conflicts between the CANBus writing configuration and that of the RS-232 port. This is important to remember if using the D-1 display to monitor the cylinder energy because you cannot exit the cylinder-to-cylinder adjustment or the energy screen using the ESC key.

In order for the CANBus to function properly, the correct CAN ID must be used. With the D-1 display, this number is 2. Please read the D-1 Display manual, if you require more information on its operation.

### Input Power

**Pins 13(+)** and **12(-)** connect the IC-100 to input power from an external power source. The rated operating range is 18–32 Vdc (steady state operation from 10 to 18 Vdc is allowable but may not be able to achieve 100% energy). Connect the buffered positive power supply terminal through a 5 A Slo-Blo fuse to pin 13 of the harness and the reference to pin 12. To ensure proper operation, the minimum input voltage (18 V) must be maintained even under load. The cross-section of the power supply leads must be at least 2.5 mm<sup>2</sup> (14 AWG).

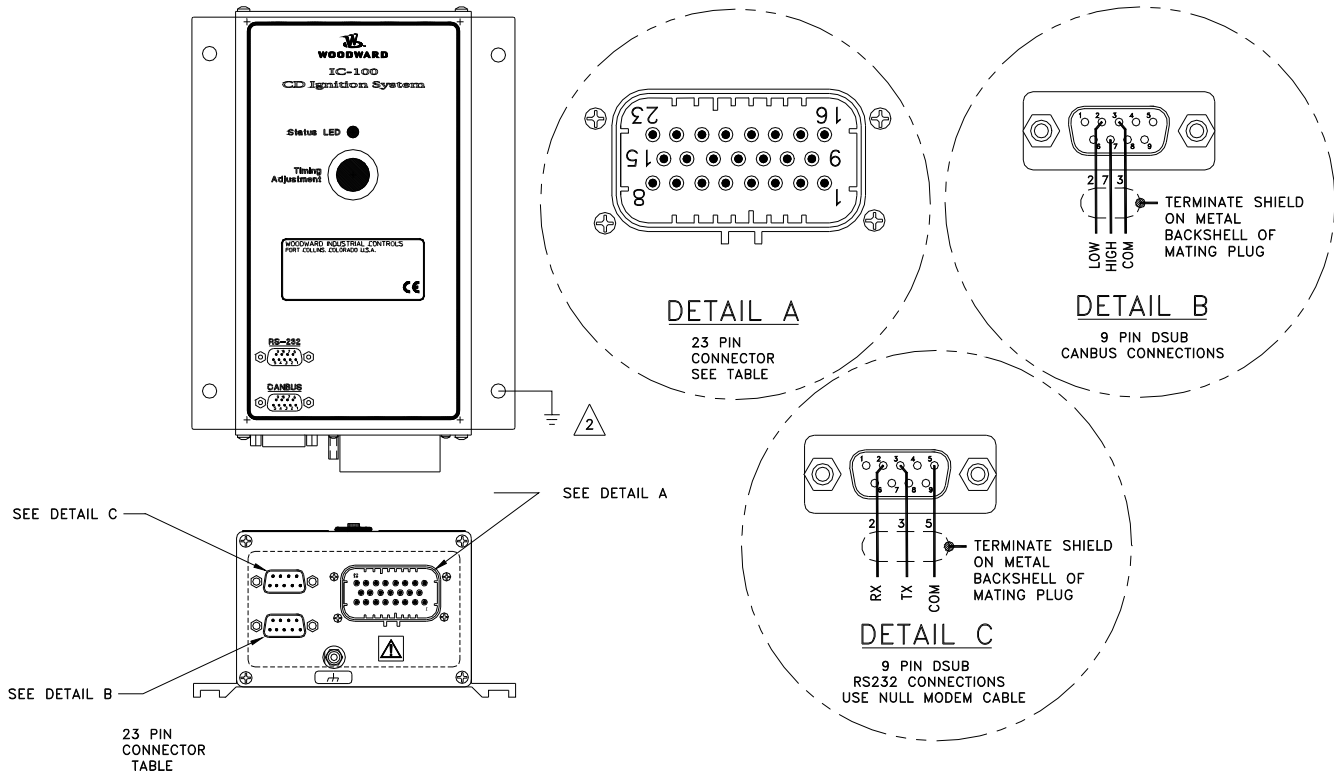

23 PIN CONNECTOR TABLE

INSIDE ENCLOSURE      OUTSIDE ENCLOSURE

23 PIN CONNECTOR      23 SOCKET CONNECTOR

1	1	TO CYLINDER 4 (IFO)	1
2	2	TO CYLINDER 3 (IFO)	
3	3	TO CYLINDER 2 (IFO)	
4	4	TO CYLINDER 1 (IFO)	
5	5	PERMISSIVE START, GO/NOGO	
6	6	0-5 VDC INPUT	
7	7	TRIGGER INPUT (+)	
8	8	ACTIVE/PASSIVE PICKUP INPUT (+)	
9	9	TO CYLINDER 5 (IFO)	
10	10	CYLINDER OUTPUT RETURN	
11	11	VOLTAGE MONITOR OUTPUT	
12	12	INPUT POWER DC (-)	
13	13	INPUT POWER DC (+) WITH 5A SLOW-BLOW FUSE	
14	14	ACTIVE PICKUP (24 VDC +) OUTPUT	
15	15	SHIELD FOR ACTIVE/PASSIVE PICKUP	
16	16	TO CYLINDER 6 (IFO)	
17	17	TO CYLINDER 7 (IFO)	
18	18	TO CYLINDER 8 (IFO)	
19	19	CONTACT SWITCH	
20	20	5 VDC (-)	
21	21	5 VDC (+)	
22	22	TRIGGER INPUT (-)	
23	23	ACTIVE/PASSIVE PICKUP INPUT (-)	

IGNITION COIL OUTPUT

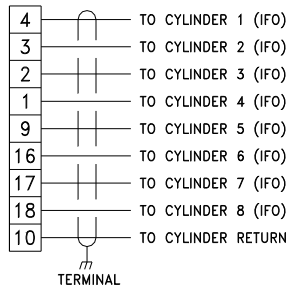

EXAMPLE FOR SIX CYLINDER ENGINE USING FIRING ORDER: 1,5,3,6,2,4

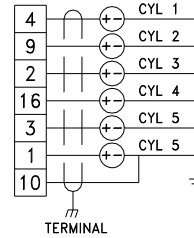

IGNITION TIMING ADJUSTMENT

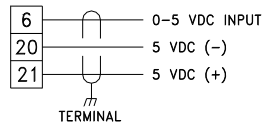

PICKUP SIGNAL INPUT

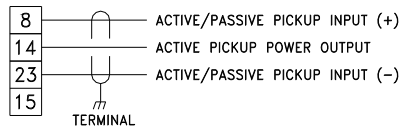

NOTES:

1 IFO: IN FIRING ORDER.

2 CONNECT IC-100 TO EARTH GROUND THROUGH MOUNTING HARDWARE OR USING A SHORT STRAP (1" X 3" BRAID).

262-025  
03-5-29

Figure 2-7. IC-100 Wiring Diagram

## Ignition Timing Adjustment

The IC-100 features two stages of variable timing adjustment:

- manual adjustment (potentiometer)
- 0–5 V analog signal

**Pins 6(+), 20(-), and 21(+5 V)** are used to receive a linear 0–5 Vdc signal for timing control.

Each method is operator-adjustable and provides up to 38° adjustment range. The resolution of the timing setting is accurate to 0.25° crankshaft degrees.

### Manual Adjustment

#### **NOTICE**

**An incorrect timing setting may lead to engine damage!**

The desired timing may be precisely set by manually rotating the potentiometer. Manual timing adjustment is possible with the engine running.

- Do not apply voltage to terminals 6, 20, or 21 of the harness.
- The desired timing setting may be obtained by rotating the potentiometer. The span between the extreme right and left position is max. 38° depending on the configuration of the IC-100 (see Setting Potentiometer Span in Chapter 3).

#### **NOTICE**

**When choosing the correct timing setting, it is essential to strictly adhere to the values specified by the engine manufacturer.**

### Analog Input

The second timing control method requires a linear 0–5 Vdc signal (for example, provided by a remote potentiometer or a boost pressure sensor).

By means of a steady 5 Vdc output and the linear 0–5 Vdc input signal, the timing is shifted further towards retard over a range of max. 35 degrees. This depends on the configuration of the IC-100 (See Analog Input Signal – 5V Limit in Chapter 3).

### Timing Examples "A" Trigger

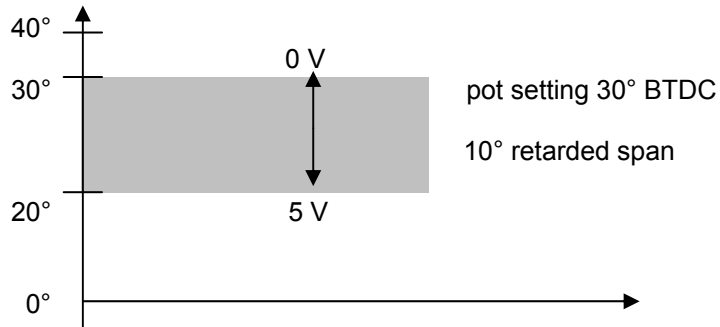

Figure 2-8. 0–5 Volt Retarded Curve

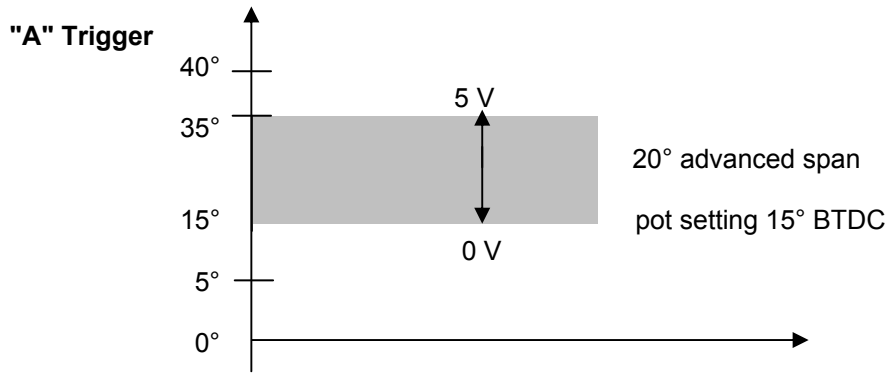
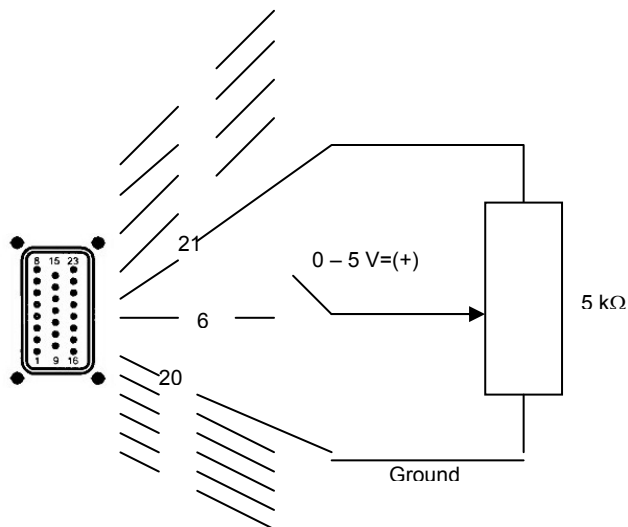

Figure 2-9. 0–5 Volt Advanced Curve

### Two-point Adjustment

A simple two-point adjustment is possible with the aid of the analog input. For example, if the engine is operated with two different grades of fuel, it is generally advisable to alter the ignition timing when changing from one type of fuel to another.



External potentiometer: 5 kA, 10-turn

Figure 2-10. Two-point Adjustment

Proceed as follows:

## IMPORTANT

The potentiometer must be installed in a shielded housing. If an input lead is required, this must also be screened. Maximum cable length: 10 m (33 ft)!

- Wire-pins 21, 6, and 20 of the harness as shown in the Figure 3-3.
- Open the switch.
- By manual adjustment, first set the ignition timing to the most advanced position by using the integrated potentiometer of the IC-100.
- Close the switch.
- Adjust the external potentiometer (0–5 Vdc) until the desired timing setting is obtained.
- You may now switch between the two fixed timing settings by opening and closing the switch in lead 6.



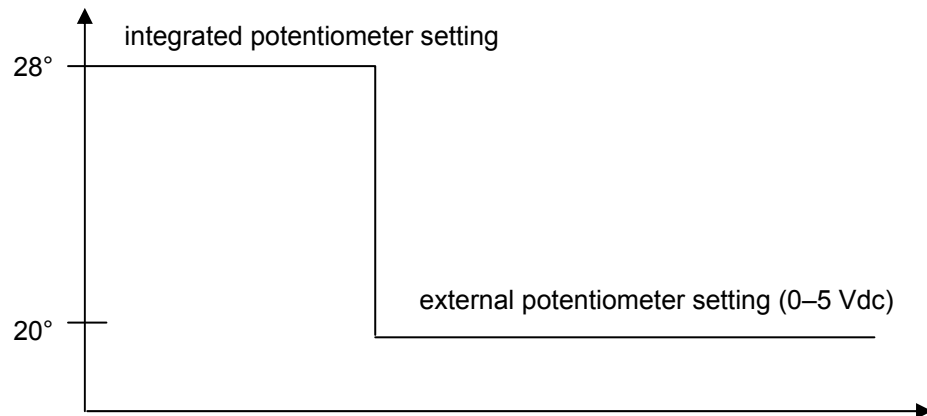

Figure 2-11. Potentiometer Setting

### Permissive Start

**Pin 5** is the Permissive Start or Go/No Go output. It is a solid-state output, capable of sinking 150 mA, that should be used to enable/disable fuel flow to the engine directly or in combination with other devices (lube oil pressure, etc.). Anytime the ignition stops due to normal stop sequence, over speed, or when a fault is detected, the Permissive Start output will de-energize. Upon start-up, the Permissive Start output will not energize until all timing signals are verified and the ignition is starting to fire. Figure 2-12 shows a likely set up for this output.

*GO/NOGO* output

not included in scope of supply

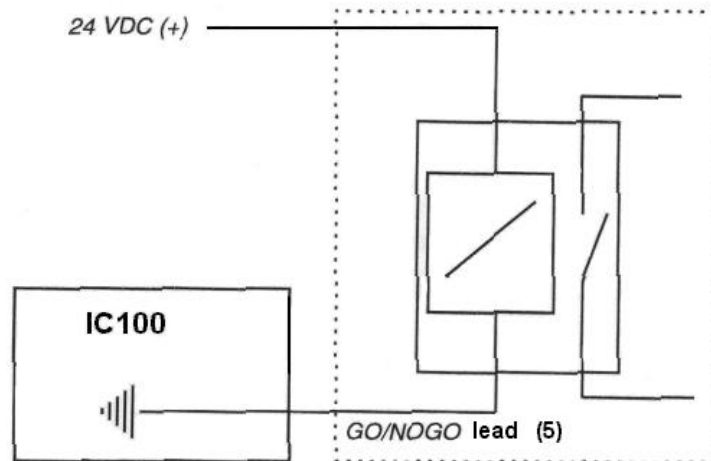



Figure 2-12. GO/NOGO Output

### Contact Switch

**Pin 19** can be set up as a switch between the timing schedules A or B. It can also be configured as an Auxiliary Shutdown Input. This needs to be programmed using the RS-232. The default is for Auxiliary Shutdown.

**Auxiliary Shutdown Input**

The IC-100 provides a low voltage, low current means of shutting down the ignition system using a PLC or similar device. If the contact switch is tied to ground, the ignition outputs will not fire. If the contact is tied to ground above the security speed (above cranking speed, but below idle), it is necessary for the rpm to go to zero before the outputs will fire. If the contact is open below the security speed, the ignition will fire immediately if the trigger, reset, and cam signals are correct.

 <b>WARNING</b>	<b>Do not use the Auxiliary Shutdown input as a primary shutdown device. Be sure to have a separate and independent shutdown device.</b>
--	--

**Timing Schedules A or B**

Two different timing schedules can be programmed to be accepted by the IC-100. The contact switch is then configured to select between the two schedules. It is possible to change timing schedules while running.

**Monitor**

**Pin 11** is a voltage output of the voltage present at the internal capacitor used to ignite the coils. The ratio is a function of the impedance of the meter. For a 10 MΩ meter impedance, the ratio is 9.23:1; and for a 1 MΩ, it is 10.2:1.

**Trigger**

**Pins 7(+)**, and **22(-)** are for the trigger timing signal. The ignition control module compares the trigger timing signal with the preprogrammed pin count and the firing patterns. Should any discrepancy occur, the ignition control module will shut down following one further complete revolution of the flywheel.

**Pickup Signal Input**

**Pins 8(+)**, and **23(-)** are used to receive either an active or passive pickup signal. **Pin 14(active pickup power)** also provides power to the active pickup unit equal to 1 V less than the power provided to the input terminals (pins 13 & 12). **Pin 15** can be used for the shield of this input. See Tables 2-1 and 2-2 for recommended connections.

connector pole	function
8	passive pickup (+)
23	passive pickup (-)
chassis ground	shielding
21	5 Vdc output
6	analog input
20	(-) signal ground
19	contact switch
5	permissive start
13	input power dc (+)
12	input power dc (-)

Table 2-1. Input Wiring with Passive Pickup

connector pole	function
14	active pickup power
8	active pickup (+)
23	active pickup (-)
chassis ground	shielding
21	5 Vdc output
6	analog input (+)
20	(-) signal ground
19	contact switch
5	permissive start
13	input power dc (+)
12	input power dc (-)

Table 2-2. Input Wiring with Active Pickup

## Ignition Coils Output Leads

The IC-100 ignition control system provides ignition energy for one to eight or two to 16-cylinder gas engines. The corresponding pin number for each cylinder in firing order is given in Table 2-3. Please note that pin 10 is used for the return/ground reference.

Ignition Module Firing Order									
connector pin	4	3	2	1	9	16	17	18	10 ground
function (cylinder)	1	2 IFO	3 IFO	4 IFO	5 IFO	6 IFO	7 IFO	8 IFO	
Engine Firing Order									
IFO = in firing order									

Table 2-3. Cylinder Output Pin-out

### NOTICE

Failure to correctly install the ring-type terminals will affect engine performance and may shorten the life of the ignition system.

The IC-100 is a negative ground system. When replacing positive ground systems by the IC-100, the wiring must be altered accordingly.

The ignition coils must be connected in series in case of double-firing engines!

## Additional Considerations

- Route the individual primary wires to the corresponding ignition coil as indicated in the wiring chart, taking care to avoid:
  - sharp edges
  - hot manifolds
  - rotating parts that could damage the installation of the wiring
- Route the primary wires through metallic, grounded sleeves.
- Trim each low voltage wire to the proper length, and crimp ring-type terminals onto their free ends.

- The ring-type terminals should be suitable for 1.5 mm<sup>2</sup> (16 AWG) wire and should have a hole diameter of 5 mm (0.2 inch).
- Use only proper crimping tools for attaching ring-type terminals.
- Use the remaining primary wire or other wire (1.5 mm<sup>2</sup>, temperature resistance: up to 125 °C/257 °F; insulation breakdown strength: min. 600 V) along with the ring-type terminals to jumper the negative ignition coil terminals.

On each engine cylinder bank, the first and last coil must be grounded to the engine block.

Starting with cylinder 1, enter the engine firing order in Table 2-4 below. Always refer to the engine manufacturer's specifications for the correct firing order.

Output Wiring	
Connector Pole	Function
4	cylinder 1
3	
2	
1	
9	
16	
17	
18	
10	ground
11	measuring output

enter firing order here

Table 2-4. Ignition Firing Order

**IMPORTANT**

**Spark plugs should be replaced for optimum ignition performance. Always follow the manufacturer's recommended gap setting and installation procedures.**

**If reusing high tension leads, make sure that they are free of breaks, cracks, oil contamination, or burns. Connectors must be clean and seat firmly.**

### Ignition Coils and High Tension Leads

**⚠ WARNING**

**HIGH VOLTAGE—Do not remove spark plug caps when the engine is running.**

- Securely mount each ignition coil on the engine as close to the spark plug as possible.
- Avoid mounting the coils on or near hot manifolds or where ambient temperatures exceed 100 °C (212 °F).
- Ensure that the high tension leads are as short as possible.

**IMPORTANT**

**Spark plug leads with integrated resistors (5 kΩ typical) are recommended.**

## Chapter 3. Operation

### Programming the IC-100 with a Laptop

In order to program the IC-100, it is necessary to download the "Ignition System tools" from [www.woodward.com/ic/software](http://www.woodward.com/ic/software). The software is designed for DOS. Install the software on your laptop according to the instructions.

When using a laptop, please note that commands are case-sensitive (capital letters must be entered as capitals, using the [SHIFT]-key).

### Programming the IC-100 with the Hand Held Programmer

Any hand held programmer needs to have the serial port configured for the following:

- Baud rate = 9600
- Data bits = 7
- No parity

#### **IMPORTANT**

The following instructions are unique for use only with the 9420-0006 hand held programmer.

Before first use, the hand held programmer must be configured.

- Switch on the programmer.
- Press [SHIFT] + [CTRL] + [F1] at the same time.
- The first parameter will be displayed.

Baud = 9600, press [F1] to continue in lines until "9600" is displayed.  
[F2] next

Data Bits = 7, press [F1] to continue in lines until "7" is displayed.  
[F2] next

Parity = ignore, press [F1] to continue in lines until "ignore" is displayed.  
[F2] next

Display Pre enabled, press [F1] to continue in lines until "enabled" is displayed.  
[F2] next

Repeat = fast, press [F1] to continue in lines until "fast" is displayed.  
[F2] next

Echo disabled, press [F1] to continue in lines until "disabled" is displayed.  
[F2] next

Handshake disabled, press [F1] to continue in lines until "disabled" is displayed.  
[F2] next

Self Test disabled, press [F1] to continue in lines until "disabled" is displayed.  
[F2] next

Power Save enabled, press [F1] to continue in lines until "enabled" is displayed.  
[F2] next

[F5] Save

Now, the hand held programmer is ready for use. When programming with the hand held programmer, only capital letters are possible.

## IC-100 Programming Overview

The following is a brief overview of the different screens available on an IC-100. A more detailed description follows under "Programmable parameters".

- |                   |   |   |
|-------------------|---|---|
| (1)               | SEQ. Number   | See Configuration Table 3-1 in this chapter.<br>Default is 23.  |
| (2)               | Reset BTDC  | Position in crank angle degrees of trigger disc basic setting. Trigger pin / hole "A" is opposite to pickup. Default is 25.   |
| (3)               | Overspeed   | Overspeed value in rpm. When reached, ignition will shut down. Default is 2200.   |
| (4)               | Security Speed  | Speed that inhibits operation of the contact switch. Default is 350.  |
| (5)               | MISFIRE RATE  | Max. allowed misfiring rate. When exceeded, ignition will shut down. Default is 0.  |
| (6)               | CAN ID #  | The range is from 1 to 31. Default is 2.  |
| (7)               | CANBus enable<br>CANBus disable   | CANBus function activated (R/W mode).<br>CANBus function deactivated (Read only). This is the default.  |
| (8)               | cyl to cyl enable<br>cyl to cyl disable   | Enables cyl-to-cyl timing. This is the default.<br>Disables cyl-to-cyl timing.  |
| (9)               | contact I/P – for stop<br><br>contact I/P – for A/B                             | Contact switch provides ON/OFF functionality (timing schedule A only). This is the default.<br>Contact switch provides timing schedule selection (timing schedule A or B) |
| (10)              | Pot timing – enable<br><br>Pot timing – disable                                 | Potentiometer function activated. This is the default.<br>Potentiometer function deactivated.   |
| (11)              | speed curve in A – in A –<br>enable<br>speed curve in A – not in A –<br>disable | Speed curve for timing schedule A activated.<br><br>Speed curve for timing schedule A deactivated.<br>This is the default.  |
| (12)              | 0 – 5 V in A – in A - enable<br>0 – 5 V in A – not in A - disable               | 0–5 V analog for timing schedule A activated.<br>0–5 V analog for timing schedule A deactivated.<br>This is the default.  |
| <sup>1</sup> (13) | speed curve in B – in B –<br>enable<br>speed curve in B – not in B –<br>disable | Speed curve for timing schedule B activated.<br><br>Speed curve for timing schedule B deactivated.<br>This is the default.  |

<sup>1</sup> (14)	0 – 5 V in B – in B - enable 0 – 5 V in B – not in B - disable	0–5 V analog for timing schedule B activated. 0–5 V analog for timing schedule B deactivated. This is the default.
(15)	Pot CCW xx.xx ADV	Crank angle degrees at CCW position. The default is 0 degrees.
(16)	Pot CW xx.xx ADV	Crank angle degrees at CW position. The default is 10 degrees.
(17)	max ADV A:	Most advanced timing point for timing schedule A (max. limit to advance). The default is 10 degrees.
(18)	max RET A:	Most retarded timing point for timing schedule A (max. limit of retard). The default is 10 degrees.
<sup>1</sup> (19)	max ADV B:	Most advanced timing point for timing schedule B (max. limit to advance). The default is 10 degrees.
<sup>1</sup> (20)	max RET B:	Most retarded timing point for timing schedule B (max. limit of retard). The default is 10 degrees.
(21)	0 V timing	Crank angle degrees offset applied to potentiometer setting for 0V input. The default is 10 degrees. ADV = "x" degree advanced from potentiometer setting. RET = "x" degree retarded from potentiometer setting.
(22)	5 V timing	Crank angle degrees offset applied to potentiometer setting for 5V input. The default is 10 degrees. ADV = "x" degree advanced from potentiometer setting. RET = "x" degree retarded from potentiometer setting.
(23)	speed points #	Number of speed points, required for speed curve (max. 5 points possible). The default is 2.
(24)	BP 1	Speed point 1 new speed = engine speed (default is 100) angle = advanced or retarded from potentiometer setting (default is 0)
	BP 2	Speed point 2 new speed = engine speed (default is 1500) angle = advanced or retarded from potentiometer setting (default is 8)
	BP3	Speed point 3 new speed = engine speed (default is 1600) angle = advanced or retarded from potentiometer setting (default is 0)
	BP4	Speed point 4 new speed = engine speed (default is 1700) angle = advanced or retarded from potentiometer setting (default is 0)

<sup>1</sup>—Not visible if (9) "contact I/P — for stop" is selected.

BP5	Speed point 5 new speed = new engine speed (default is 1800) angle = advanced or retarded from potentiometer setting (default is 0)
(25) End / Start	ESC – quit programming mode

## Function Key Overview

### The Main Screen will contain the following information:

RPM	: 0	speed
0 – 5 V	: 0	analog input signal
SPARK	: 00,00	ignition timing
ENERGY LEVEL	: 100%	energy in %
STATUS: READY		ignition status

### The following menus may be accessed while the engine is running except self test

#### [S]:

[C]	: cyl. to cyl. menu
[E]	: energy level menu
[H]	: for Rev, Hours and software rev. no.
[M]	: actual misfires and miss/sec
[S]	: self test

#### Sub Menus:

[F1]	: Change Parameter
[F2]	: Next
[F3]	: Previous
[F4]	: Help
[F5]	: Save



**The engine must be stopped to access any other menus!**

## Programming of Parameters

Prior to operating the IC-100, it must be configured in regards to engine and application. Programming is done by computer software or the handheld. The connection is established via a serial computer interface and a cable to the RS-232 port of the IC-100.



**The IC-100 should only be programmed by trained personnel.**

### If access to programming is needed, proceed as follows:

- Switch on voltage supply to the IC-100, connect the IC-100 to the hand held or the computer and start the terminal software.
- The main screen is displayed.
- Press [H] to obtain the engine hours.
- Press [ESC]—If the engine is already in operation, the ignition module cannot switch to the programming mode.
- Enter password which is the number of hours +10. For example, if the number of hours displayed when [H] was pressed was 2, the password would be 12.
- Press [Enter] to reach programming level. The first parameter is displayed.
- General information for setting parameters:
  - [F1] change parameter and confirm with [Enter]. Every parameter change has to be saved with [F5]
  - [F2] scrolls ahead to the next parameter
  - [F3] scrolls back to the previous parameter



- [F4] displays a short clarification of the current parameter  
 [F5] save parameter  
 [ESC] quit programming level and start IC-100  
 [F10] quit program (PC only)

**IMPORTANT**

Hit [ESC] to exit programming mode before exiting [F10] the DOS program for PC only OR disconnect the hand held.

After setting IC-100 parameters, we recommend switching off the supply voltage in order to reset the IC-100. If the CANBus is activated, the supply voltage must be switched off, since the ignition will be started in a different mode. Leave the supply voltage off for at least 20 seconds to ensure that all possible faults are reset.

All programmable parameters must be set according to the engine application before operation.

Some of the submenus are available when engine is running:

- [C] : cyl. to cyl. menu  
 [E] : energy level menu  
 [H] : for Rev, Hours and software rev. no.  
 [M] : actual misfires and miss/sec

## Programmable Parameters

### (1) SEQ. Number

IC-100 Sequence Table

Sequence No.	No. of Outputs	Magnet Disc	Firing Degrees	Disc Location	Unit Firing Order
1	2	2 + 1	360-360	cam	A-B
2	3	3 + 1	240-240	cam	A-B-C
3	3	3 + 1	120-120	crank	A-B-C
4	6	3 + 1	50-70	crank	A-B-C-D-E-F
5	6	3 + 1	30-90	crank	A-B-C-D-E-F
6	6	3 + 1	90-30	crank	A-B-C-D-E-F
7	2	4 + 1	90-90	crank	A-B
8	4	4 + 1	180-180	cam	A-B-C-D
9	4	4 + 1	90-90	crank	A-B-C-D
10	8	4 + 1	20-70	crank	A-B-C-D-E-F-G-H
11	8	4 + 1	60-30	crank	A-B-C-D-E-F-G-H
12	8	4 + 1	45-45	crank	A-B-C-D-E-F-G-H
13	8	4 + 1	30-60	crank	A-B-C-D-E-F-G-H
14	5	5 + 1	72-72	crank	A-B-C-D-E
15	5	5 + 1	144-144	cam	A-B-C-D-E
16	6	6 + 1	120-120	cam	A-B-C-D-E-F
17	3 *	6 + 1	60-180	crank	A-B-E
18	4 *	6 + 1	120-60	crank	A-C-D-F
19	6	6 + 1	60-60	crank	A-B-C-D-E-F
20	7	7 + 1	102.8-102.8	cam	A-B-C-D-E-F-G
21	7	7 + 1	51.43-51.43	crank	A-B-C-D-E-F-G
22	8	8 + 1	90-90	cam	A-B-C-D-E-F-G-H
23	8	8 + 1	45-45	crank	A-B-C-D-E-F-G-H
24	2 *	6 + 1	360-360	cam	A-D
25	3 *	6 + 1	240-240	cam	A-C-E
26	4 *	6 + 1	180-180	cam	A-D-E-H
27	8	6 + 1	120-60	cam	A-B-C-D-E-F-G-H

\*NOTE—Firing order/sequence. Rev 2.46 (and higher) allows adjustment of 6 outputs for cylinder-to-cylinder timing in the RS-232 menu and the CANBus.

Sequence 26 allows all 8 outputs to be adjusted.

All outputs in the firing order are displayed. Make sure to match the output letter in the table above to the output that is being adjusted.

Letters are used instead of numbers for the firing order: A is the first in the firing order, followed by B, C, D, E, F, G, H.

[F1] enter sequence no. and press [Enter]

[F5] to save

[F2] to advance to the next screen

If the sequence table is not available, press:

[F4] shows the selected sequence number and the firing pattern. Press <U> or <D> to scroll through the sequence table.

### (2) Reset BTDC

The reset BTDC parameter is the basic setting of the IC-100. The basic setting of the trigger disc or the trigger pins / holes may be between 25° and 60°. The IC-100 program allows electronic compensation of the trigger points. For more information see Chapter 2 (Setting the Ignition Timing Adjustment Range). For final adjustment follow the start up procedure later in this chapter.

[F2] to advance to the next screen

### (3) Overspeed

Press [F1], enter desired speed in RPM for limit, then press [Enter].

[F5] to save

[F2] to advance to the next screen

## WARNING

The engine should be equipped with an overspeed shutdown device to protect against runaway or damage to the prime mover with possible personal injury, loss of life, or property damage.

The overspeed shutdown device must be totally independent of the prime mover control system. An overtemperature or overpressure shutdown device may also be needed for safety, as appropriate.

## NOTICE

The ignition will be shut down if the overspeed limit is reached!

Power must be cycled to the IC-100 after an overspeed shutdown condition to clear the fault.

### (4) Security Speed (start-up speed)

This is essentially a programmable 'Run' speed setting that controls the operation of the Contact Switch input. Security Speed is rendered inoperable when the Contact Switch input is not connected or is not configured as a "Stop" Contact (see 'Contact I/P' programming).

The Stop Contact enables or disables the primary outputs.

- **Below** the Security Speed but above 30 rpm (approx.), the primary outputs will fire or stop firing each time the Stop Contact is opened (ungrounded) or closed (grounded).
- **Above** the Security Speed the primary outputs will stop firing when the Stop Contact is closed and will not fire again until the engine has come to a full stop (zero rpm is sensed) and the engine is re-started.

- **Above** the Security Speed the primary outputs will fire if the Stop Contact was closed and is opened for the first time. This allows engine starting when the Security Speed is set below cranking speed.

Typically the Security Speed is set above cranking speed and below minimum or idle speed.

Programming Sequence:

1. Press F1 to change security speed or F2 to skip.
2. Enter security speed, then press ENTER.
3. Press F5 to save.
4. Press F2 to program next parameter.

Range: Valid from 0 rpm to 'overspeed' rpm setting.

#### (5) Misfire Rate

The number of misses per second that is permissible before the engine shuts down due to misfire rate exceeded. To disable, set misfire rate to zero or 255. The most sensitive setting is 1. Please note that damaged leads may cause misfires.

1. Press F1 to change misfire rate or F2 to skip.
2. Enter misfire rate, then press ENTER.
3. Press F5 to save.
4. Press F2 to program next parameter.



**WARNING**

Disabling this function may cause personal injury or engine damage.

#### (6) CAN-ID #

Specify desired CANBus protocol. The default is 2 which allows communication with a D1 display.

[F1]

CAN ID #

1ST TYPE NEW: Please enter "2".

ENTER WHEN DONE Press [Enter]

[F5] to save

[F2] to advance to the next screen

#### (7) CAN BUS ENABLED / DISABLED

The CANBus function should only be activated if an engine management system controls the ignition timing via CANBus.

[F1]

ENABLED activated

DISABLED deactivated

[F5] to save

[F2] to advance to the next screen

Contact the factory for the CANBus communication protocol.

#### (8) Cylinder-to-Cylinder Timing (toggle with [F1])

IC-100 units are equipped with cylinder-to-cylinder timing adjustment capability. This allows fine tuning of each cylinder ignition timing, individually. See Chapter 3 (Additional Functions).

[F1] ENABLE activate

[F2] DISABLE deactivate

[F5] save

**(9) Function of Contact Lead 19**

Contact lead 19 allows choice between two functions:

CONTACT I/P FOR STOP A/B

F1

F1 CONTACT FOR STOP      Ignition can be STOPPED and STARTED via this lead

F2 CONTACT FOR A/B

Switching this lead allows shifting between 2 timing schedules, A or B. A or B can have different timing for the potentiometer and 0–5 Volt. It is possible to have a speed curve enabled or disabled for both A and B schedules.

**(10) Activating Potentiometer**

The integrated potentiometer of the IC-100 can be disabled after making the settings, in order to lock this feature for the operator.

POT TIMING ENABLED / DISABLED

F1

ENABLE                      activated

DISABLE                    deactivated

F5                              save

**(11) Speed Curve in Timing Schedule A**

The IC-100 offers programming of a speed curve / speed ramp. That means, depending on the actual engine speed, a certain timing is chosen. This aims at reaching optimal gas combustion.

SPEED CURVE IN A / NOT IN A

F1

ENABLE                      activated / function is used

DISABLE                    deactivated / function is not used

F5                              save

**(12) Analog Input Signal for Timing Schedule A**

In addition to the potentiometer adjustment and the speed curve, it is possible to change the ignition timing by using the analog input signal.

Example:

A knock monitoring system can change the ignition timing linear. In that case the knock monitoring system sends the analog output signal 0–5 Vdc to the ignition system depending on the level of engine knocking.

0 – 5 V IN A / NOT IN A

F1

ENABLE                      activated / function is used

DISABLE                    deactivated / function is not used

F5                              save

**(13) Speed Curve in Timing Schedule B**

It is possible to program a different speed curve / speed ramp for timing schedule B. Thus a different ignition timing is given depending on actual engine speed.

By setting a speed dependent ignition timing an optimal gas combustion can be achieved.

SPEED CURVE IN B / NOT IN B

F1

ENABLE                    activated / function is used

DISABLE                  deactivated / function is not used

F5                            save

**(14) Analog Input Signal for Timing Schedule B**

Additionally to the potentiometer adjustment and the speed curve it is possible to change the ignition timing by using the analog input signal.

Example:

A knock monitoring system can change the ignition timing linear. In that case the knock monitoring system sends the analog output signal 0–5 Vdc to the ignition system depending on the level of engine knocking.

0 – 5 V IN B / NOT IN B

F1

ENABLE                    activated / function is used

DISABLE                  deactivated / function is not used

F5                            save

**(15) Setting the Potentiometer Span—CCW Position**

The left limit (CCW) of the potentiometer can be set as timing angle.

POT CCW x.xx ADV

F1

1ST TYPE NEW        enter value

F1: ADVANCE        BTDC (before top dead center)

F2: RETARD            most retarded (0.00°)

F5                            save

**(16) Setting Potentiometer Span—CW Position**

The right limit (CW) of the potentiometer can be set as timing angle.

POT CW x.xx ADV

F1

1ST TYPE NEW        enter value

F1: ADVANCE        BTDC (before top dead center)

F2: RETARD            most retarded (0.00°)

F5                            save

**Ignition Timing**

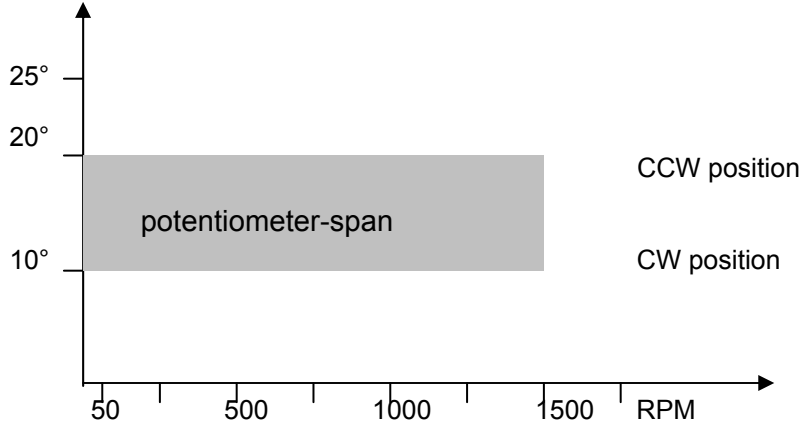

**(17) Timing Schedule A—Maximum Limit of Advanced Ignition**

In order to avoid engine damage by addition of the various ignition relevant parameters, it is possible to set a maximum ignition limit.

MAX ADV IN A: xx.xx ADV

F1

1ST TYPE NEW: enter value

THEN ENTER press [ENTER]

F1: ADVANCE BTDC (before top dead center)

F2: RETARD most retarded (0.00°)

F5 save

**(18) Timing Schedule A—Maximum Limit Retarded Ignition**

In order to avoid engine damage by addition of the various ignition relevant parameters, it is possible to set a minimum ignition limit.

MIN ADV IN A: xx.xx ADV

F1

1ST TYPE NEW: enter value

THEN ENTER press [ENTER]

F1: ADVANCE BTDC (before top dead center)

F2: RETARD most retarded (0.00°)

F5 save

**Ignition Timing**

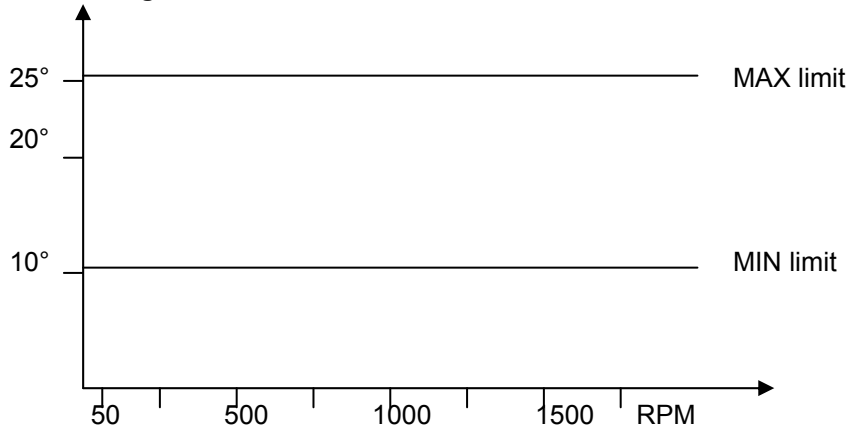

**(19) Analog Input Signal—0 Volt Limit**

Rotation direction and span, direct or indirect effect of the 0–5 Volt signal can be programmed with end points retarded or advanced. The 0–5 Volt signal (advance or retard) will be added to or deducted from the potentiometer and speed curve (if activated).

The value of change has to be entered as a figure in degrees when the 0 Volt signal is received.

```

0V TIMING x.xx ADV
1ST TYPE NEW      enter value
ENTER
F1: ADVANCE      advance (addition to existing curve)
F2: RETARD       retard (deduction from existing curve)
F5               save
  
```

**(20) Analog Input Signal—5 Volt Limit**

Rotation direction and span, direct or indirect effect of the 0–5 Volt signal can be programmed with end points retarded or advanced. The 0–5 Volt signal (advance or retard) will be added to or deducted from the potentiometer and speed curve (if activated).

The value of change has to be entered as a figure in degrees when the 5 Volt signal is received.

```

5V TIMING x.xx ADV
1ST TYPE NEW      enter value
ENTER
F1: ADVANCE      advance (addition existing curve)
F2: RETARD       retard (deduction from existing curve)
F5               save
  
```

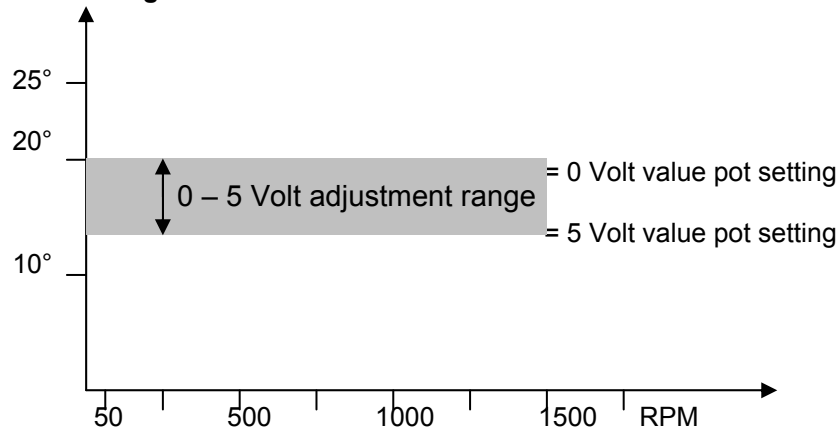
**Ignition Timing**

**Ignition Timing**

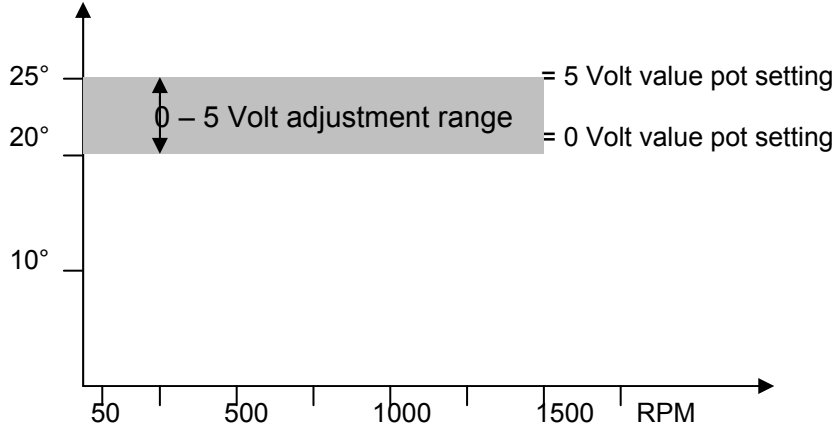

**(21) Speed Points**

For programming a speed dependent curve max. speed of 5 points can be set. The speed curve should be worked out before you start programming the data!

SPEED POINTS: x  
 1ST TYPE NEW:           enter value  
 ENTER WHEN DONE       press [ENTER]  
 F5                           save

**(22) Setting Speed Points BP1 to BP5**

Setting the speed points always requires a speed and a degree value. The degree value will be added to (ADV) or deducted from (RET) the potentiometer curve which is always 0 (zero).

BP1: x.xx ADV  
 NEW SPEED               enter speed  
 ENTER WHEN DONE       press [ENTER]  
 F1: ADVANCE             add  
 F2: RETARD               deduct

Follow these instructions for the remaining speed points.

**Example of a typical speed curve of an engine (generator operation) with a speed curve to influence the start-up procedure positively:**

When the engine is not running, the ignition timing is equal to the potentiometer setting. Thus the ignition timing can also be checked with the programmer or a laptop when the engine is out of operation. Even if the engine is started the ignition timing will be reduced and increased again from 50 revolutions until it reaches the preset value at 1000 revolutions.

SPEED POINTS           : 3                   number of speed points  
 BP1                       : 0                    speed  
                               0 ADV               angle  
 F5  
 BP2                       : 50                  speed  
                               10 RET             angle  
 F5  
 BP3                       : 1000               speed  
                               0 ADV               angle  
 F5



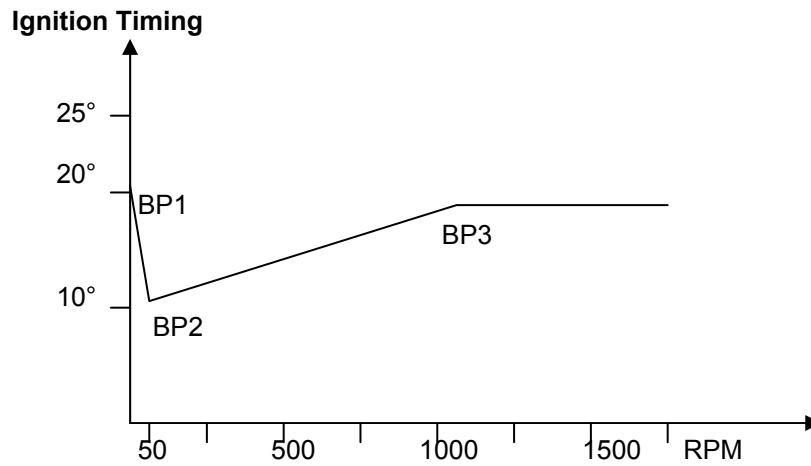

### Example of Programming an IC-100

Potentiometer A	:	enabled
speed curve A	:	enabled
0 – 5 V analog input	:	enabled
Potentiometer CCW	:	22° ADV
Potentiometer CW	:	18° ADV
max. advance	:	25° ADV
max. retard	:	5° ADV
0 – 5 Volt Signal - 0 Volt	:	0° RET
0 – 5 Volt Signal - 5 Volt	:	5° RET
number of speed points	:	3
BP1	:	0 RPM
		0° RET
BP2	:	50 RPM
		15° RET
BP3	:	1000 RPM
		0° RET

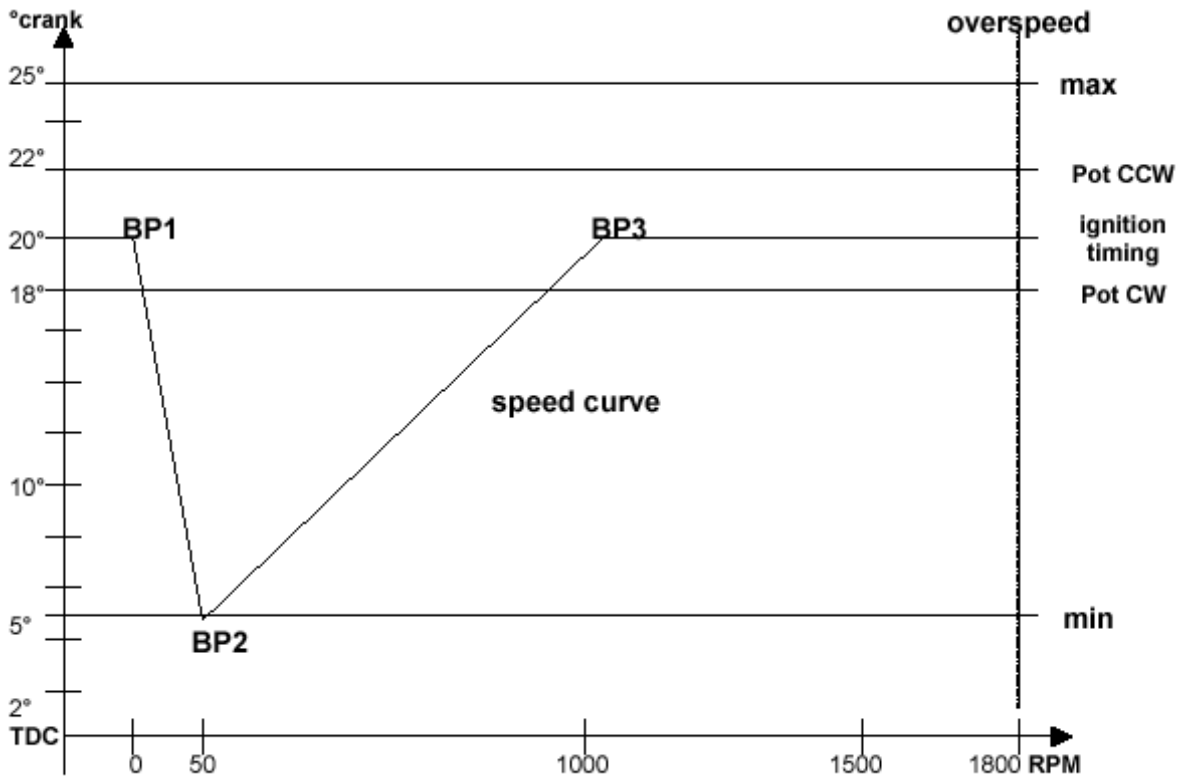

Enter your programmed data here:

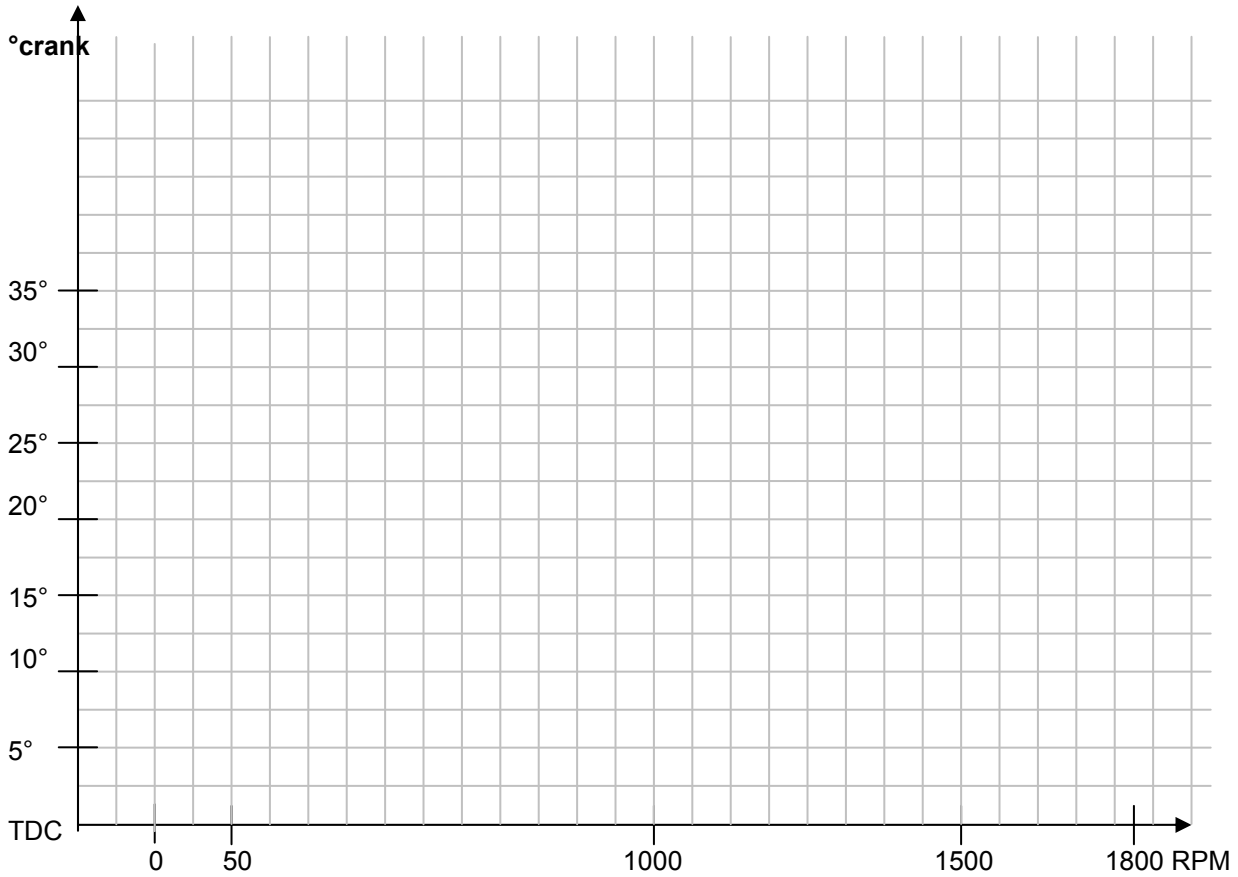

## Additional Functions

### Ignition Energy Levels

Depending on the gas quality and the application, it is possible to vary the available ignition energy.

You may set any value between 20–100%.

Fast-burning gases like propane require relatively small energy, whereas slow-burning gases like sewage gas require high energy, to ignite the gas.

To change the preset values proceed as follows:

- press "E"
- press "F1"
- enter new value
- press "Enter"
- press "F5" to save changes

### Cylinder-to-Cylinder Timing

The cylinder-to-cylinder timing allows changing the adjustment for single cylinders, to optimize ignition firing.

The ignition timing of each cylinder can be shifted by  $\pm 2^\circ$  from the global setting.

However, you should use this option only if suitable instrumentation is available to analyze the position with the most effective compression, in order to immediately judge the result.

### Activating Cylinder-to-Cylinder-Timing

#### **IMPORTANT**

ADV is  $^\circ$  advanced from the global setting.  
RET is  $^\circ$  retarded from the global setting.

See Table 2-4, Ignition Firing Order, for sequence of connections and firing order.

Press "F5" to save all cylinder adjustment values. Leave the cylinder-to-cylinder menu by pressing "ESC". Now you can disconnect the programmer from the IC-100 without losing any data.

The IC-100 primary outputs do not consider the direction of rotation. Pin "4" is always the first cylinder of the firing order, "3" is the second, "2" the third, etc. (see Table 2-4).

To activate cylinder-to-cylinder timing, proceed as follows. The function cylinder-to-cylinder-adjustment is started during engine operation by pressing [C] using the programmer.

The following menu is displayed:

```

CYL #1 x.xx ADV / RET
F1 CHANGE          value can be changed
F2 NEXT            call next ignition output
F3 PREVIOUS        back to previous output
F5 SAVE            save
  
```

To change values proceed as follows:

```

[F2]                until ignition output of the cylinder, which is to be
                    optimized, appears
  
```

```

[F1]
1ST TYPE IN NEW    enter delta value (max. 2°)
THEN ENTER
  
```

```

[ENTER]
  
```

```

F1 ADVANCE         change to position advanced from global setting
F2 RETARD          change to position retarded from global setting
  
```

```

F5                save
  
```

## Initial Start-up Procedure



**WARNING** An improperly installed ignition system may lead to engine damage and could pose threat of personal injury to operators.

### I. Before applying power to the IC-100, check and verify the following:

1. Fuel valve is shut off.
2. The firing interval (sequence number) is correct for the engine type. If you are not sure, contact your engine manufacturer.
3. Cylinder firing order is known and the ignition coils are wired to the correct outputs in accordance with the Cylinder Output Pin-out Table 2-3.
4. Timing sensor is properly gapped and tightened.
5. Timing sensor is wired in accordance with Table 2-1 or Table 2-2.

### II. Apply power to the IC-100 (fuel valve still in the off position):

1. Check and verify that the IC-100 is programmed correctly.
2. Perform the normal engine start-up procedure (prelube, etc.), except that the fuel must remain OFF.
3. With a timing light connected to the #1 cylinder, verify that the cylinder is firing within  $\pm 2$  degrees of the programmed setting. If not, refer to Chapter 4.
4. Check all remaining cylinders for proper timing. If not correct, stop the engine and recheck wiring and sequence number for correctness.
5. Disengage the starter. Continue with step III if no problems are encountered.

**III. Set the fuel valve to its normal position.**

1. Follow the normal starting procedure and start the engine.
2. If the engine fails to start, refer to Chapter 4.
3. If the engine starts, re-verify timing of #1 cylinder.
4. Increase engine speed to normal operating speed.
5. Check timing of #1 cylinder and compare measured timing to the displayed timing (PC/laptop with monitor program or hand held terminal is required).
6. If the IC-100 displayed value is too high, the programmed reset position (Reset BTDC parameter) needs to be reduced by the difference.

**Example:**

If the IC-100 monitor is displaying 22.0° BTDC and the actual measured timing is 20.5° BTDC, the programmed reset position will have to be reduced by 1.5 degrees (22–20.5). So, if the programmed reset position (Reset BTDC parameter) is 50 degrees Adv., the programmed reset position will have to be changed to 48.5 degrees Adv.

If the IC-100 displayed value is too low compared to the measured timing, the programmed reset position will have to be increased by the difference.

7. If necessary, stop the engine using the normal shutdown procedure and change the programmed reset position (Reset BTDC parameter).
8. Re-start the engine and verify that the #1 cylinder is firing at the correct position.
9. Check all remaining cylinders for proper timing. If not correct, stop the engine immediately and recheck wiring and sequence number for correctness.

# Chapter 4.

## Maintenance and Troubleshooting

### Maintenance



#### WARNING

Switch off the engine and disconnect the power supply before commencing any installation work!

An improperly installed ignition system may lead to engine damage and could pose threat of personal injury to operators.

The IC-100 ignition control module is not intended for repair by the end user. See Chapter 5 for service options.

The remaining parts of the ignition control system should be serviced as follows:

- The pickups might need to be replaced if they operate under extreme thermal conditions ( $> 90\text{ }^{\circ}\text{C}/194\text{ }^{\circ}\text{F}$ ).
- All control system cables should be carefully examined for signs of damage and replaced if necessary.
- All plug connections should be checked to ensure that they are in a serviceable condition.
- The spark plugs should be serviced according to the specifications of the spark plug and engine manufacturer.

### Faults and Troubleshooting

The IC-100 includes an LED, which indicates faults by flashing once or several times.

flashing	system status	possible problem
continuous flashing	normal operation with ignition firing	none
1 flash	normal READY mode, 0 rpm	none
1 flash	no pickup signal	defective pickup or incorrect wiring of pickup
2 flashes	bad pickup signal	sequence number does not match timing
3 flashes	engine speed too low	increase cranking speed / check sequence number and timing disc
4 flashes	engine overspeed	engine overspeed or set point too low
5 flashes	low supply voltage	defective supply/battery or undersized wire
6 flashes	programming mode	none
6 flashes	configuration error	incorrect parameters programmed, bad data identified in non-volatile memory, bad pickup signal at $> 200\text{ rpm}$

Table 4-1. LED Flash Codes

The ignition system is comprised of the following components that have to be taken into consideration when searching for faults:

- ignition control module
- harness
- ignition coils
- high tension leads
- ground leads
- spark plugs
- shutdown equipment

Most ignition system failures occur outside the ignition control module. The cause may lie in any one of the above components or in the connections between them.

The following troubleshooting guide is divided into three sections:

- input fault diagnosis
- low or high voltage ignition circuits
- ignition control module self test function

### Input Fault Diagnosis

If a fault is detected in the inputs to the IC-100, the ignition control module will automatically shut down the ignition. The cause of the fault must be corrected before the engine can be restarted.

Input faults which might cause shutdown are:

- open circuit or short-circuit to ground in the input power circuit
- open circuit or short-circuit to ground in the engine starting circuit
- loss of input power or supply voltage too low

#### Power supply circuit:

### NOTICE

Supply voltages below the specified values will impair the operation of the ignition control module and may cause the engine to stall. Supply voltages above the specified values could damage the ignition control module.

The following minimum and maximum input voltages must be maintained:

**Minimum 10 Vdc**

**Maximum 32 Vdc**

**Input voltages outside these values may damage the IC-100.**

If damping of the supply voltage is suspected, verify with a voltmeter. Check the start/stop circuit for any opens, shorts or accidental connections to ground.

#### Faulty pickup signal:

If a timing signal fault is detected during operation, the ignition control module automatically shuts down the ignition. Such a fault could result from the failure of a pickup, an open, short-circuited, or grounded connection to a pickup, or a physical change in the characteristics of a passive trigger.

Proceed as follows:

- Crank the engine with the fuel valve closed and check all signals at the pickup connectors using an oscilloscope.
- Verify minimum 2.5 V square wave signal.

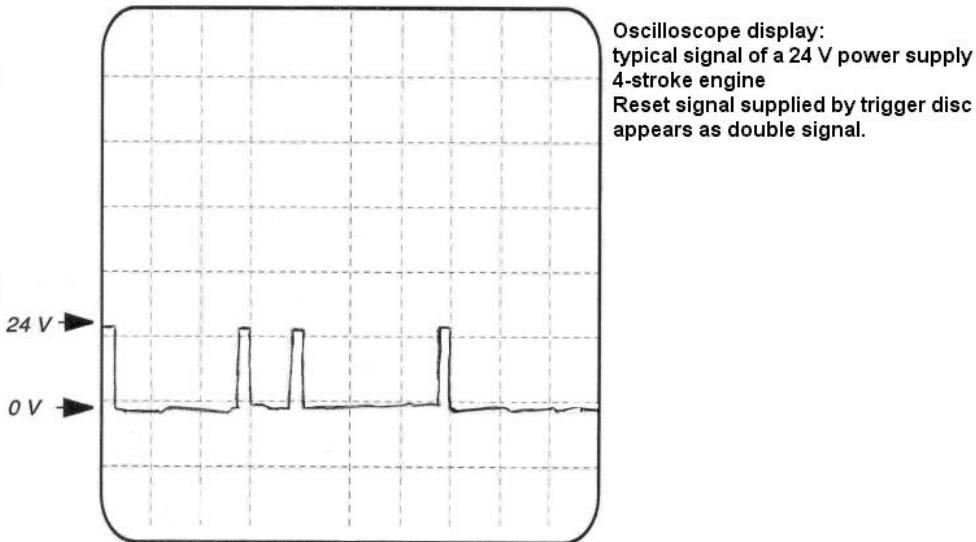

Figure 4-1. Oscilloscope—Square Wave Signal

**IMPORTANT**

Two LEDs are installed in the connector cap of the reset pickup. The colors indicate the following:  
green—power supply connected  
orange—trigger signal

**Low or High Voltage Ignition Circuits**

- Track the ignition circuit current flow if the engine is missing on one or more cylinders, but not completely dead.
- Apply an inductive timing light to the high tension leads to determine which cylinder is not firing.

**IMPORTANT**

The brightness of the firing indicator bulb is not a measure of the actual strength of the respective output signal; it only reflects the voltage required by the spark plug itself.

Determine which lead in the harness is connected to the malfunctioning cylinder.

- Stop the engine and unplug the output harness connector from the ignition control module.
- Use an ohmmeter with a scale of R x 1.
- Connect one ohmmeter probe to the harness connector pin of the malfunctioning cylinder and the other to the engine ground.
- Read the measured resistance.  
The resistance on the low voltage side should lie within the values specified below.  
If this is the case, the low voltage ignition circuit is not the cause of the fault.



ignition coil	primary resistance	secondary resistance (HV)
9100.0002	1.10—1.45 $\Omega$	10.70—11.80 k $\Omega$
9100.0001	0.60—0.80 $\Omega$	7.50—9.50 k $\Omega$

**IMPORTANT**

All ohmmeters have a certain error margin which may lie between 3 and 5%.

If lower values are measured, this indicates that the low voltage supply lead to the ignition coil is grounded or the ignition coil low voltage winding is short-circuited.

If higher values than those listed above are measured, this indicates poor connections, a fault in the ignition coil low voltage winding, or a poor engine ground.

- To locate this fault, the harness ring-type connectors must be disconnected from the ignition coil.
- Connect one ohmmeter probe to the negative terminal of the ignition coil and the other to the engine ground.
- Read the measured resistance.

**Resistance within the values specified above:**

Fault in the harness lead or harness plug connector.

**Resistance outside the values specified above:**

Defective ignition coil or poor ground connection.

If you have still not located the fault, proceed as follows:

- Connect one ohmmeter probe to the positive terminal and the other to the negative terminal of the ignition coil.
- Read the measured resistance.

**Resistance within the values specified above:**

Poor ground connection.

**Resistance outside the values specified above:**

Defective ignition coil.

If you still have not located the fault, proceed as follows:

- Disconnect the output harness from the ignition control module!
- Remove the spark plug cap from the spark plug. Do not yet remove the ignition coil.
- Select the R x 100 or R x 1000 scale and connect the ohmmeter probes between the spark plug cap and ground.
- The resistance on the high voltage side of the ignition coil should be within the values specified above.

**Resistance within the values specified above:**

Defective spark plug or defective ignition control module.

**Resistance outside the values specified above:**

Defective spark plug lead or ignition coil, or poor ground connection.

If you have still not located the fault, proceed as follows:

- Disconnect the spark plug lead from the ignition coil.
- Measure the resistance between the ignition coil high voltage output and the engine ground. The resistance on the high voltage side should lie within the values specified above.

## **IMPORTANT**

**If your spark plug boots have integrated resistance, you must subtract this resistance from your measured values!**

### **Resistance within the values specified above:**

Defective spark plug lead or spark plug boot.

### **Resistance outside the values specified above:**

Defective ignition coil or poor ground connection.

If you have still not located the fault, proceed as follows:

- Connect one ohmmeter probe to the ignition coil high voltage output and the other to the ignition coil ground terminal. The measured resistance should lie within the values specified above.

### **Resistance within the values specified above:**

Defective ground connection.

### **Resistance outside the values specified above:**

Defective ignition coil.

## **Ignition Control Module Self Test Function**

### **! WARNING**

It is critical that the fuel to the engine be shut off and the engine purged of any fuel gas before starting the self-test. Failure to do this could result in personal injury or damage to equipment.

### **! WARNING**

**HIGH VOLTAGE**—Warn all personnel to avoid contact with the ignition coils or primary and secondary wiring before starting the self-test. Failure to avoid contact could result in personal injury.

### **NOTICE**

**Do not crank the engine while the self-test is active!**

The self-test feature of the IC-100 allows the operator/mechanic to conduct performance checks on the wiring to the coil, the ignition coil, high tension leads, and spark plugs by discharging the energy stored in the high voltage capacitor into each coil in successive order. The IC-100 will “fire” a cylinder every 0.1 second. The energy delivered to each coil is fixed at 70%.

On this screen, you must enter the password to enable the self-test. Pressing “S” (upper case) from the main screen starts the self-test feature. Pressing “S” (upper case) again from the main screen stops the self-test feature. While in self-test, proper performance of each cylinder can be checked using standard troubleshooting tools (timing light, voltmeter, etc.).

## Chapter 5. Service Options

### Product Service Options

If you are experiencing problems with the installation, or unsatisfactory performance of a Woodward product, the following options are available:

- Consult the troubleshooting guide in the manual.
- Contact the manufacturer or packager of your system.
- Contact the Woodward Full Service Distributor serving your area.
- Contact Woodward technical assistance (see “How to Contact Woodward” later in this chapter) and discuss your problem. In many cases, your problem can be resolved over the phone. If not, you can select which course of action to pursue based on the available services listed in this chapter.

**OEM and Packager Support:** Many Woodward controls and control devices are installed into the equipment system and programmed by an Original Equipment Manufacturer (OEM) or Equipment Packager at their factory. In some cases, the programming is password-protected by the OEM or packager, and they are the best source for product service and support. Warranty service for Woodward products shipped with an equipment system should also be handled through the OEM or Packager. Please review your equipment system documentation for details.

**Woodward Business Partner Support:** Woodward works with and supports a global network of independent business partners whose mission is to serve the users of Woodward controls, as described here:

- A **Full Service Distributor** has the primary responsibility for sales, service, system integration solutions, technical desk support, and aftermarket marketing of standard Woodward products within a specific geographic area and market segment.
- An **Authorized Independent Service Facility (AISF)** provides authorized service that includes repairs, repair parts, and warranty service on Woodward's behalf. Service (not new unit sales) is an AISF's primary mission.
- A **Recognized Engine Retrofitter (RER)** is an independent company that does retrofits and upgrades on reciprocating gas engines and dual-fuel conversions, and can provide the full line of Woodward systems and components for the retrofits and overhauls, emission compliance upgrades, long term service contracts, emergency repairs, etc.
- A **Recognized Turbine Retrofitter (RTR)** is an independent company that does both steam and gas turbine control retrofits and upgrades globally, and can provide the full line of Woodward systems and components for the retrofits and overhauls, long term service contracts, emergency repairs, etc.

A current list of Woodward Business Partners is available at [www.woodward.com/support/directory.cfm](http://www.woodward.com/support/directory.cfm).

## Woodward Factory Servicing Options

The following factory options for servicing Woodward products are available through your local Full-Service Distributor or the OEM or Packager of the equipment system, based on the standard Woodward Product and Service Warranty (5-01-1205) that is in effect at the time the product is originally shipped from Woodward or a service is performed:

- Replacement/Exchange (24-hour service)
- Flat Rate Repair
- Flat Rate Remanufacture

**Replacement/Exchange:** Replacement/Exchange is a premium program designed for the user who is in need of immediate service. It allows you to request and receive a like-new replacement unit in minimum time (usually within 24 hours of the request), providing a suitable unit is available at the time of the request, thereby minimizing costly downtime. This is a flat-rate program and includes the full standard Woodward product warranty (Woodward Product and Service Warranty 5-01-1205).

This option allows you to call your Full-Service Distributor in the event of an unexpected outage, or in advance of a scheduled outage, to request a replacement control unit. If the unit is available at the time of the call, it can usually be shipped out within 24 hours. You replace your field control unit with the like-new replacement and return the field unit to the Full-Service Distributor.

Charges for the Replacement/Exchange service are based on a flat rate plus shipping expenses. You are invoiced the flat rate replacement/exchange charge plus a core charge at the time the replacement unit is shipped. If the core (field unit) is returned within 60 days, a credit for the core charge will be issued.

**Flat Rate Repair:** Flat Rate Repair is available for the majority of standard products in the field. This program offers you repair service for your products with the advantage of knowing in advance what the cost will be. All repair work carries the standard Woodward service warranty (Woodward Product and Service Warranty 5-01-1205) on replaced parts and labor.

**Flat Rate Remanufacture:** Flat Rate Remanufacture is very similar to the Flat Rate Repair option with the exception that the unit will be returned to you in “like-new” condition and carry with it the full standard Woodward product warranty (Woodward Product and Service Warranty 5-01-1205). This option is applicable to mechanical products only.

## Returning Equipment for Repair

If a control (or any part of an electronic control) is to be returned for repair, please contact your Full-Service Distributor in advance to obtain Return Authorization and shipping instructions.

When shipping the item(s), attach a tag with the following information:

- return authorization number;
- name and location where the control is installed;
- name and phone number of contact person;
- complete Woodward part number(s) and serial number(s);
- description of the problem;
- instructions describing the desired type of repair.

## Packing a Control

Use the following materials when returning a complete control:

- protective caps on any connectors;
- antistatic protective bags on all electronic modules;
- packing materials that will not damage the surface of the unit;
- at least 100 mm (4 inches) of tightly packed, industry-approved packing material;
- a packing carton with double walls;
- a strong tape around the outside of the carton for increased strength.

### NOTICE

To prevent damage to electronic components caused by improper handling, read and observe the precautions in Woodward manual 82715, *Guide for Handling and Protection of Electronic Controls, Printed Circuit Boards, and Modules*.

## Replacement Parts

When ordering replacement parts for controls, include the following information:

- the part number(s) (XXXX-XXXX) that is on the enclosure nameplate;
- the unit serial number, which is also on the nameplate.

## Engineering Services

Woodward offers various Engineering Services for our products. For these services, you can contact us by telephone, by email, or through the Woodward website.

- Technical Support
- Product Training
- Field Service

**Technical Support** is available from your equipment system supplier, your local Full-Service Distributor, or from many of Woodward's worldwide locations, depending upon the product and application. This service can assist you with technical questions or problem solving during the normal business hours of the Woodward location you contact. Emergency assistance is also available during non-business hours by phoning Woodward and stating the urgency of your problem.

**Product Training** is available as standard classes at many of our worldwide locations. We also offer customized classes, which can be tailored to your needs and can be held at one of our locations or at your site. This training, conducted by experienced personnel, will assure that you will be able to maintain system reliability and availability.

**Field Service** engineering on-site support is available, depending on the product and location, from many of our worldwide locations or from one of our Full-Service Distributors. The field engineers are experienced both on Woodward products as well as on much of the non-Woodward equipment with which our products interface.

For information on these services, please contact us via telephone, email us, or use our website: [www.woodward.com/support](http://www.woodward.com/support).

## How to Contact Woodward

For assistance, call one of the following Woodward facilities to obtain the address and phone number of the facility nearest your location where you will be able to get information and service.

### Electrical Power Systems

<u>Facility</u> -----	<u>Phone Number</u>
Brazil -----	+55 (19) 3708 4800
China -----	+86 (512) 6762 6727
Germany:	
Kempen----	+49 (0) 21 52 14 51
Stuttgart----	+49 (711) 78954-0
India -----	+91 (129) 4097100
Japan-----	+81 (43) 213-2191
Korea-----	+82 (51) 636-7080
Poland-----	+48 12 618 92 00
United States----	+1 (970) 482-5811

### Engine Systems

<u>Facility</u> -----	<u>Phone Number</u>
Brazil -----	+55 (19) 3708 4800
China -----	+86 (512) 6762 6727
Germany:	
Stuttgart----	+49 (711) 78954-0
India -----	+91 (129) 4097100
Japan-----	+81 (43) 213-2191
Korea-----	+82 (51) 636-7080
The Netherlands-	+31 (23) 5661111
United States----	+1 (970) 482-5811

### Turbine Systems

<u>Facility</u> -----	<u>Phone Number</u>
Brazil -----	+55 (19) 3708 4800
China -----	+86 (512) 6762 6727
India -----	+91 (129) 4097100
Japan-----	+81 (43) 213-2191
Korea-----	+82 (51) 636-7080
The Netherlands-	+31 (23) 5661111
United States----	+1 (970) 482-5811

You can also contact the Woodward Customer Service Department or consult our worldwide directory ([www.woodward.com/support/directory.cfm](http://www.woodward.com/support/directory.cfm)) for the name of your nearest Woodward distributor or service facility.

## Technical Assistance

If you need to telephone for technical assistance, you will need to provide the following information. Please write it down here before phoning:

Your Name	_____
Site Location	_____
Phone Number	_____
Fax Number	_____
<hr/>	
Engine/Turbine Model Number	_____
Manufacturer	_____
Number of Cylinders (if applicable)	_____
Type of Fuel (gas, gaseous, steam, etc)	_____
Rating	_____
Application	_____
<hr/>	
<b>Control/Governor #1</b>	
Woodward Part Number & Rev. Letter	_____
Control Description or Governor Type	_____
Serial Number	_____
<hr/>	
<b>Control/Governor #2</b>	
Woodward Part Number & Rev. Letter	_____
Control Description or Governor Type	_____
Serial Number	_____
<hr/>	
<b>Control/Governor #3</b>	
Woodward Part Number & Rev. Letter	_____
Control Description or Governor Type	_____
Serial Number	_____

*If you have an electronic or programmable control, please have the adjustment setting positions or the menu settings written down and with you at the time of the call.*

## Appendix. Programming Overview

Here is a good place to enter the values you programmed.

<b>Customer</b>	
<b>Engine Type / Model</b>	
<b>Engine Serial Number</b>	
<b>Number of Cylinders</b>	
<b>Ignition Timing Point</b>	

(1) firing pattern = sequence-no.		
(2) reset position BTDC	nominal:	actual:
(3) overspeed		
(4) security speed (max. starting speed)		
(5) misfire rate		
(6) CAN ID		
(7) CANBus	<input type="checkbox"/> enabled	<input type="checkbox"/> disabled
(8) cyl-to-cyl timing	<input type="checkbox"/> enabled	<input type="checkbox"/> disabled
(9) contact switch 19 enabled for:	<input type="checkbox"/> ON/OFF ignition <input type="checkbox"/> 2-potentiometer operation	
(10) potentiometer function	<input type="checkbox"/> enabled	<input type="checkbox"/> disabled
(11) speed curve potentiometer A	<input type="checkbox"/> enabled	<input type="checkbox"/> disabled
(12) 0 – 5 V in A	<input type="checkbox"/> enabled	<input type="checkbox"/> disabled
(13) speed curve potentiometer B	<input type="checkbox"/> enabled	<input type="checkbox"/> disabled
(14) 0 – 5 V in B	<input type="checkbox"/> enabled	<input type="checkbox"/> disabled
(15) potentiometer max. angle stop left (CCW):	ADV – BTDC:	RET – ATDC:
(16) potentiometer max. angle stop right (CW):	ADV – BTDC:	RET – ATDC:
(17) most advanced timing point for potentiometer A:		
(18) most retarded timing point for potentiometer A:		
(19) most advanced timing point for potentiometer B:		
(20) most retarded timing point for potentiometer B:		

(22) adjustment of timing point given by analog signal, input signal: 5 Volt:									
ADV =      degree advanced					RET =      degree retarded				
(23) number of speed points required for speed curve (max. 5 points):									
(24) speed points									
	BP1	BP2	BP3	BP4	BP5				
speed									
retard angle									
Additional functions:									
[Shift] + [E]    energy (10 % - 100 %):									
[Shift] + [H]    operating hours					Date:			op. hours:	
[Shift] + [C]: cylinder – cylinder adjustment									
ignition output:	4	3	2	1	9	16	17	18	10
firing order									ground
change									
(+) ADV									
(-) RET									

\_\_\_\_\_ Date

\_\_\_\_\_ Signature





## DECLARATION OF CONFORMITY

According to EN 45014

**Manufacturer's Name:** WOODWARD GOVERNOR COMPANY (WGC)  
Industrial Controls Group

**Manufacturer's Address:** 1000 E. Drake Rd.  
Fort Collins, CO, USA, 80525

**Model Name(s)/Number(s):** IC-100 Ignition Controller  
8408-005 and similar

**Conformance to Directive(s):** 2004/108/EC COUNCIL DIRECTIVE of 15 December 2004 on the approximation of the laws of the Member States relating to electromagnetic compatibility and all applicable amendments.

2006/95/EC COUNCIL DIRECTIVE of 12 December 2006 on the harmonization of the laws of Member States relating to electrical equipment designed for use within certain voltage limits.

**Applicable Standards:** EN61000-6-4, (2007): EMC Part 6-4: Generic Standards – Emissions for Industrial Environments.  
EN61000-6-2, (2005): EMC Part 6-2: Generic Standards – Immunity for Industrial Environments.

EN50178, January 1997: Electronic Equipment for Use in Power Installations

We, the undersigned, hereby declare that the equipment specified above conforms to the above Directive(s).

### MANUFACTURER

  
\_\_\_\_\_  
**Signature**

Suhail Horan  
\_\_\_\_\_  
**Full Name**

**Full Name**

Quality Manager  
\_\_\_\_\_  
**Position**

**Position**

WGC, Fort Collins, CO, USA  
\_\_\_\_\_  
**Place**

**Place**

01-MAR-10  
\_\_\_\_\_  
**Date**

# IC-100 Control Specifications

Power Consumption	24 V operation: 18–32 Vdc (2.2 A max.) 10–18 Vdc (3.5 A max) steady state operation is allowable but may not be able to achieve 100% energy. Average current is dependent on the number of cylinders, input power, energy level, and engine speed. Peak current is dependent only on energy level; 100% energy = 20 A peak
Trigger Input	Variable reluctance (passive) +2 Vdc min., 80 V p-p max, 10 Hz to 10 kHz
Sensor Inputs	0–5 V sensors
Permissive Start (solid-state output)	Open collector (NPN) 60 V max., 150 mA max
Communications Ports	CAN, RS-232
Maximum Case Temperature	70 °C (158 °F) [see Chapter 1 for details]
Ambient Operating Temperature	–40 to +55 °C (–40 to +131 °F)
Storage Temperature	–40 to +85 °C (–40 to +185 °F)
Mechanical Vibration	SV2: 4g, 5–2000 Hz and RV1: 8.2 Grms, 10–2000 Hz
Mechanical Shock	MS1: 40g peak, 11 ms sawtooth
Air Quality	Pollution Degree II
Installation Overvoltage	Category II
Ingress Protection	IP40

## Regulatory Compliance

European Compliance for CE Mark:  
EMC Directive

Declared to 2004/108/EC COUNCIL DIRECTIVE of 15 December 2004 on the approximation of the laws of the member states relating to electromagnetic compatibility.

Low Voltage Directive

Declared to the 2006/95/EC COUNCIL DIRECTIVE of 12 December 2006 on the harmonization of the laws of the Member States relating to electrical equipment designed for use within certain voltage limits.

We appreciate your comments about the content of our publications.

Send comments to: [icinfo@woodward.com](mailto:icinfo@woodward.com)

Please reference publication **26205B**.



B26205:B



PO Box 1519, Fort Collins CO 80522-1519, USA  
1000 East Drake Road, Fort Collins CO 80525, USA  
Phone +1 (970) 482-5811 • Fax +1 (970) 498-3058

Email and Website—[www.woodward.com](http://www.woodward.com)

Woodward has company-owned plants, subsidiaries, and branches,  
as well as authorized distributors and other authorized service and sales facilities throughout the world.

Complete address / phone / fax / email information for all locations is available on our website.