

37441B



DTSC-50 ATS Controller



Manual
Software Version starting from 1.0000

Manual 37441B

**WARNING**

Read this entire manual and all other publications pertaining to the work to be performed before installing, operating, or servicing this equipment. Practice all plant and safety instructions and precautions. Failure to follow instructions can cause personal injury and/or property damage.

The engine, turbine, or other type of prime mover should be equipped with an overspeed (overtemperature, or overpressure, where applicable) shutdown device(s), that operates totally independently of the prime mover control device(s) to protect against runaway or damage to the engine, turbine, or other type of prime mover with possible personal injury or loss of life should the mechanical-hydraulic governor(s) or electric control(s), the actuator(s), fuel control(s), the driving mechanism(s), the linkage(s), or the controlled device(s) fail.

Any unauthorized modifications to or use of this equipment outside its specified mechanical, electrical, or other operating limits may cause personal injury and/or property damage, including damage to the equipment. Any such unauthorized modifications: (i) constitute "misuse" and/or "negligence" within the meaning of the product warranty thereby excluding warranty coverage for any resulting damage, and (ii) invalidate product certifications or listings.

**CAUTION**

To prevent damage to a control system that uses an alternator or battery-charging device, make sure the charging device is turned off before disconnecting the battery from the system.

Electronic controls contain static-sensitive parts. Observe the following precautions to prevent damage to these parts.

- Discharge body static before handling the control (with power to the control turned off, contact a grounded surface and maintain contact while handling the control).
- Avoid all plastic, vinyl, and Styrofoam (except antistatic versions) around printed circuit boards.
- Do not touch the components or conductors on a printed circuit board with your hands or with conductive devices.

**OUT-OF-DATE PUBLICATION**

This publication may have been revised or updated since this copy was produced. To verify that you have the latest revision, be sure to check the Woodward website:

<http://www.woodward.com/pubs/current.pdf>

The revision level is shown at the bottom of the front cover after the publication number. The latest version of most publications is available at:

<http://www.woodward.com/publications>

If your publication is not there, please contact your customer service representative to get the latest copy.

Important definitions**WARNING**

Indicates a potentially hazardous situation that, if not avoided, could result in death or serious injury.

**CAUTION**

Indicates a potentially hazardous situation that, if not avoided, could result in damage to equipment.

**NOTE**

Provides other helpful information that does not fall under the warning or caution categories.

Woodward reserves the right to update any portion of this publication at any time. Information provided by Woodward is believed to be correct and reliable. However, Woodward assumes no responsibility unless otherwise expressly undertaken.

© Woodward
All Rights Reserved.

Revision History

Rev.	Date	Editor	Change
NEW	09-08-28	TE	Release
A	09-10-09	TE	Minor corrections
B	10-03-10	TE	UL Certification

Content

CHAPTER 1. GENERAL INFORMATION	7
Related Documents.....	7
Overview	8
CHAPTER 2. DTSC-50 OVERVIEW.....	10
CHAPTER 3. ELECTROSTATIC DISCHARGE AWARENESS	11
CHAPTER 4. HOUSING	12
Dimensions / Panel Cut-Out.....	12
Installation	13
CHAPTER 5. WIRING DIAGRAMS	14
CHAPTER 6. CONNECTIONS.....	15
Terminal Arrangement	15
Power supply	16
Voltage Measuring	17
Voltage Measuring: Generator	18
Voltage Measuring: Mains.....	20
Discrete Inputs	22
Discrete Inputs: Bipolar Signals	22
Discrete Inputs: Operation Logic.....	23
Relay Outputs.....	24
Interfaces.....	25
Overview	25
DPC - Direct Configuration Cable	26
CHAPTER 7. OPERATION AND NAVIGATION	27
Operation and Display.....	28
Purpose of the Status LEDs.....	28
Operating the DTSC-50	28
Acknowledging Alarm Messages	28
Configuring the DTSC-50.....	29
Display of the Operating Values.....	29
Default Operating Value Display	30
Cycling Through the Displayed Operating Values	30
Alarm Messages	33
Configuration Displays	35
Display Hierarchy	37

CHAPTER 8. FUNCTIONAL DESCRIPTION	38
Overview	38
Operating Modes	39
Operating Mode STOP	39
Operating Mode MANUAL	40
Breaker Closure Limits	47
Generator Circuit Breaker	47
Mains Circuit Breaker	47
Functional Description of the 2 nd CB Close Delay Time	48
CHAPTER 9. CONFIGURATION.....	49
Restoring Default Values	49
Resetting Via the Front Panel	49
Resetting Via LeoPC1	49
Configuration Via the Front Panel	49
Configuration Using the PC	50
Editing the Configuration File	51
CHAPTER 10. PARAMETERS.....	52
Measuring	53
Application	54
Engine	55
Engine: Start/Stop Automatic	55
Breaker	56
Emergency Power (AMF)	57
Password	58
Monitoring	59
Monitoring: Generator	59
Monitoring: Generator Overfrequency	59
Monitoring: Generator Underfrequency	60
Monitoring: Generator Overvoltage	61
Monitoring: Generator Undervoltage	62
Monitoring: Mains	63
Monitoring: Mains Failure Limits	63
Monitoring: Engine Start Fail	65
Monitoring: Breakers	65
Monitoring: Engine Unintended Stop	66
Discrete Inputs	67
Relay Outputs	68
Counter	70
System	72
Codes	72
Factory Settings	72
Parameter Access Level	72
Versions	73
CHAPTER 11. EVENT LOGGER.....	74
GetEventLog Software	74
Installing GetEventLog	74
Starting GetEventLog	74
Resetting the Event Logger	75
CHAPTER 12. TECHNICAL DATA	76
CHAPTER 13. ACCURACY.....	78

APPENDIX A. COMMON	79
Alarm Classes	79
Conversion Factors and Charts	80
Conversion Factors: Temperature	80
Conversion Factors: Pressure	80
Conversion Chart: Wire Size.....	80
APPENDIX B. FRONT CUSTOMIZATION	81
APPENDIX C. TROUBLESHOOTING	82
APPENDIX D. LIST OF PARAMETERS	85
APPENDIX E. SERVICE OPTIONS.....	89
Product Service Options.....	89
Returning Equipment For Repair.....	89
Packing a Control.....	90
Return Authorization Number RAN	90
Replacement Parts.....	90
How To Contact Woodward	91
Engineering Services	92
Technical Assistance	93

Illustrations and Tables

Illustrations

Figure 1-2: Functional overview.....	8
Figure 4-1: Housing - panel cut-out.....	12
Figure 5-1: Wiring diagram – DTSC-50.....	14
Figure 6-1: DTSC-50 back view - terminal arrangement.....	15
Figure 6-2: Power supply.....	16
Figure 6-3: Voltage measuring - generator 3Ph 4W.....	18
Figure 6-4: Voltage measuring - generator 3Ph 3W.....	18
Figure 6-5: Voltage measuring - generator 1Ph 3W.....	18
Figure 6-6: Voltage measuring - generator 1Ph 2W, phase-neutral.....	19
Figure 6-7: Voltage measuring - generator 1Ph 2W, phase-phase.....	19
Figure 6-8: Voltage measuring - mains 3Ph 4W.....	20
Figure 6-9: Voltage measuring - mains 3Ph 3W.....	20
Figure 6-10: Voltage measuring - mains 1Ph 3W.....	20
Figure 6-11: Voltage measuring - mains 1Ph 2W.....	21
Figure 6-12: Discrete inputs - alarm/control input - positive signal.....	22
Figure 6-13: Discrete inputs - alarm/control input - negative signal.....	23
Figure 6-14: Discrete inputs - alarm/control inputs - operation logic.....	23
Figure 6-15: Relay outputs.....	24
Figure 6-16: Interfaces - overview.....	25
Figure 7-1: Front panel and display.....	27
Figure 7-2: 6 digit 7 segment LED display.....	29
Figure 10-1: Voltage/frequency hysteresis.....	64
Figure 11-1: GetEventLog - interface configuration.....	74
Figure 11-2: GetEventLog - event logger content.....	75
Figure 13-4: Paper strip.....	81

Tables

Table 1-1: Manual - overview.....	7
Table 4-1: Housing - panel cut-out.....	12
Table 6-1: Power supply - terminal assignment.....	16
Table 6-2: Voltage measuring principles.....	17
Table 6-3: Voltage measuring - terminal assignment - generator voltage.....	19
Table 6-4: Voltage measuring - terminal assignment - mains voltage.....	21
Table 6-5: Discrete input - terminal assignment - alarm/control input - positive signal.....	22
Table 6-6: Discrete input - terminal assignment - alarm/control inputs - negative signal.....	23
Table 6-7: Relay outputs - terminal assignment, part 1.....	24
Table 6-8: Interfaces - connection overview.....	25
Table 7-1: Display - default operating value.....	30
Table 7-2: Display of operating values.....	32
Table 7-3: Alarm classes.....	33
Table 7-4: Alarm messages.....	34
Table 7-5: Configuration displays.....	37
Table 7-6: Display hierarchy.....	37
Table 8-1: Functional description - Overview.....	38
Table 10-1: Relay outputs - list of configurable parameters.....	69
Table 11-1: Event logger - operation states.....	75
Table 13-1: Conversion factor: temperature.....	80
Table 13-2: Conversion factor: pressure.....	80
Table 13-3: Conversion chart: wire size.....	80

Chapter 1. General Information



Related Documents



Type	English	German
DTSC-50		
DTSC-50 – Manual	this manual ⇨	37441
Additional Manuals		
LeoPC1 – User Manual <small>PC program for configuration, parameter visualization, remote control, data logging, language upload, alarm and user management, and event recorder management. This manual describes the use of LeoPC1 software.</small>	37146	GR37146
LeoPC1 – Engineering Manual <small>PC program for configuration, parameter visualization, remote control, data logging, language upload, alarm and user management, and event recorder management. This manual describes the programming of LeoPC1 software.</small>	37164	GR37164

Table 1-1: Manual - overview

Overview

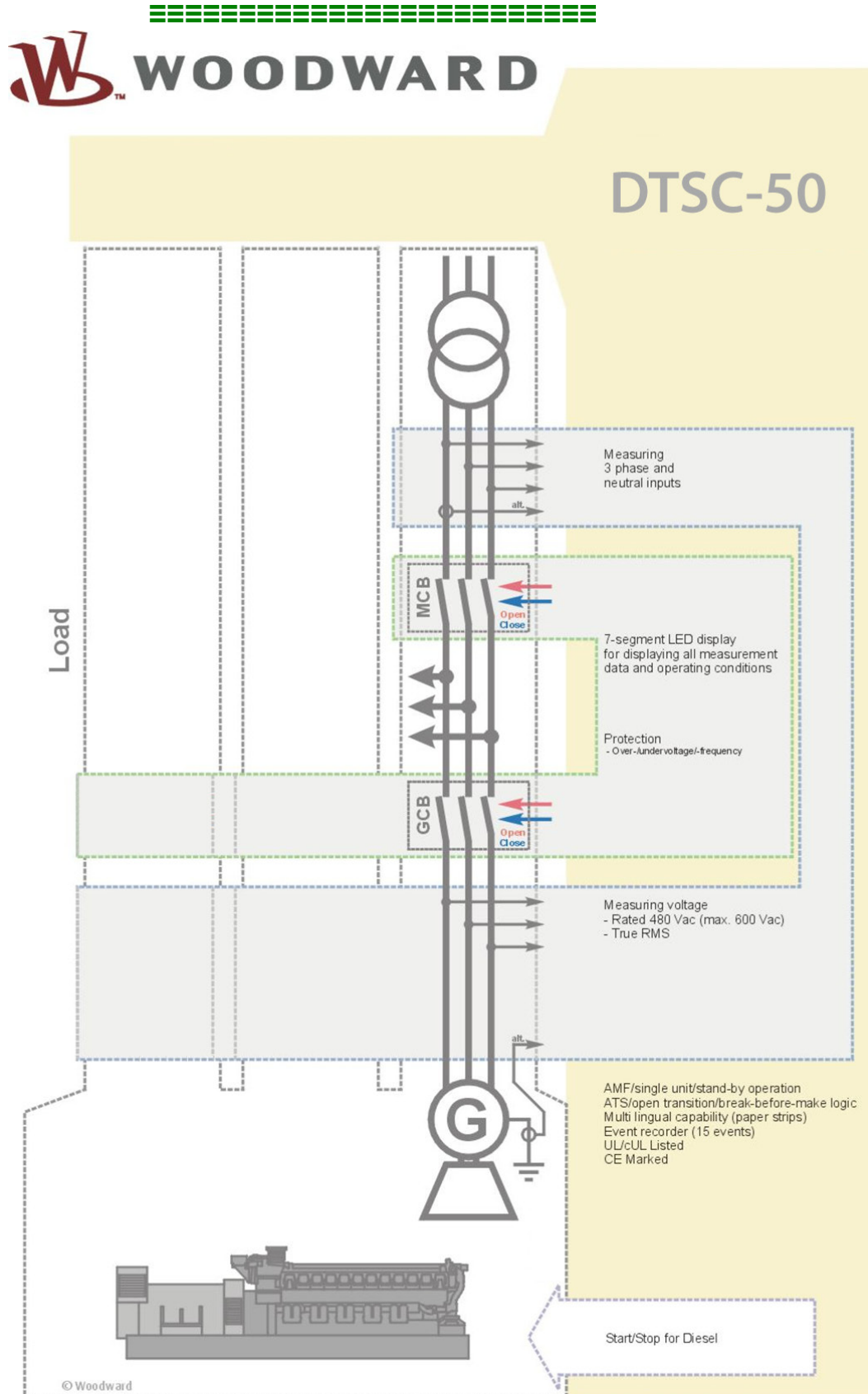

Figure 1-2: Functional overview

The DTSC-50 generator set controller provides the following functions:

- Genset control
- Engine and generator protection
- Engine data measurement -
 - including battery voltage, service hours, etc.
- Generator voltage measurement
- Alarm display with circuit breaker trip and engine shutdown
- AMF (automatic mains failure) standby genset control with automatic engine start on a mains failure detection and open transition breaker control
- Password protected configuration

Intended Use The control unit must only be operated as described in this manual. The prerequisite for a proper and safe operation of the product is correct transportation, storage, and installation as well as careful operation and maintenance.



NOTE

This manual has been developed for a unit fitted with all available options. Inputs/outputs, functions, configuration screens and other details described, which do not exist on your unit may be ignored.

The present manual has been prepared to enable the installation and commissioning of the unit. Because of the large variety of parameter settings, it is not possible to cover every possible combination. The manual is therefore only a guide. In case of incorrect entries or a total loss of functions, the default settings can be taken from the enclosed list of parameters.

Chapter 2.

DTSC-50 Overview



NOTE

Some parameters of the DTSC-50 can only be configured using the Direct Configuration Cable DPC (P/N 5417-557) and a notebook/PC with the software LeoPC1. These parameters are indicated with an **L** in the parameter description under Parameters starting from page 52 and can not be configured at the unit directly.

The configuration with LeoPC1 via the DPC is described under Configuration Using the PC on page 50. The DPC is not part of the DTSC-50 shipment and sold separately (P/N 5417-557).



IMPORTANT NOTE ABOUT COUNTERS

The counters for

- Operation hours
- Maintenance Interval
- Number of starts

can be recalibrated with LeoPC1 and the configuration files belonging to the unit. If 3rd party users are not allowed to change these values, you can easily remove the parameters which enable changing the counters by editing the LeoPC1 configuration files as described under Editing the Configuration File on page 51.

The counter for

- Maintenance Interval

can also be recalibrated using the front panel. You may prevent the user from recalibrating this parameter by setting a HMI password as described under Codes on page 72.

Chapter 3.

Electrostatic Discharge Awareness

All electronic equipment is static-sensitive, some components more than others. To protect these components from static damage, you must take special precautions to minimize or eliminate electrostatic discharges.

Follow these precautions when working with or near the control.

1. Before performing maintenance on the electronic control, discharge the static electricity on your body to ground by touching and holding a grounded metal object (pipes, cabinets, equipment, etc.).
2. Avoid the build-up of static electricity on your body by not wearing clothing made of synthetic materials. Wear cotton or cotton-blend materials as much as possible because these do not store static electric charges as much as synthetics.
3. Keep plastic, vinyl, and Styrofoam materials (such as plastic or Styrofoam cups, cup holders, cigarette packages, cellophane wrappers, vinyl books or folders, plastic bottles, and plastic ash trays) away from the control, the modules, and the work area as much as possible.
4. **Opening the control cover may void the unit warranty.**
Do not remove the Printed Circuit Board (PCB) from the control cabinet unless absolutely necessary. If you must remove the PCB from the control cabinet, follow these precautions:
 - Ensure that the device is completely de-energized (all connectors must be disconnected).
 - Do not touch any part of the PCB except the edges.
 - Do not touch the electrical conductors, connectors, or components with conductive devices with your hands.
 - When replacing a PCB, keep the new PCB in the protective antistatic bag it comes in until you are ready to install it. Immediately after removing the old PCB from the control cabinet, place it in the protective antistatic bag.



CAUTION

To prevent damage to electronic components caused by improper handling, read and observe the precautions in Woodward manual 82715, *Guide for Handling and Protection of Electronic Controls, Printed Circuit Boards, and Modules*.



NOTE

The unit is capable to withstand an electrostatic powder coating process with a voltage of up to 85 kV and a current of up to 40 μ A.

Chapter 4. Housing

Dimensions / Panel Cut-Out

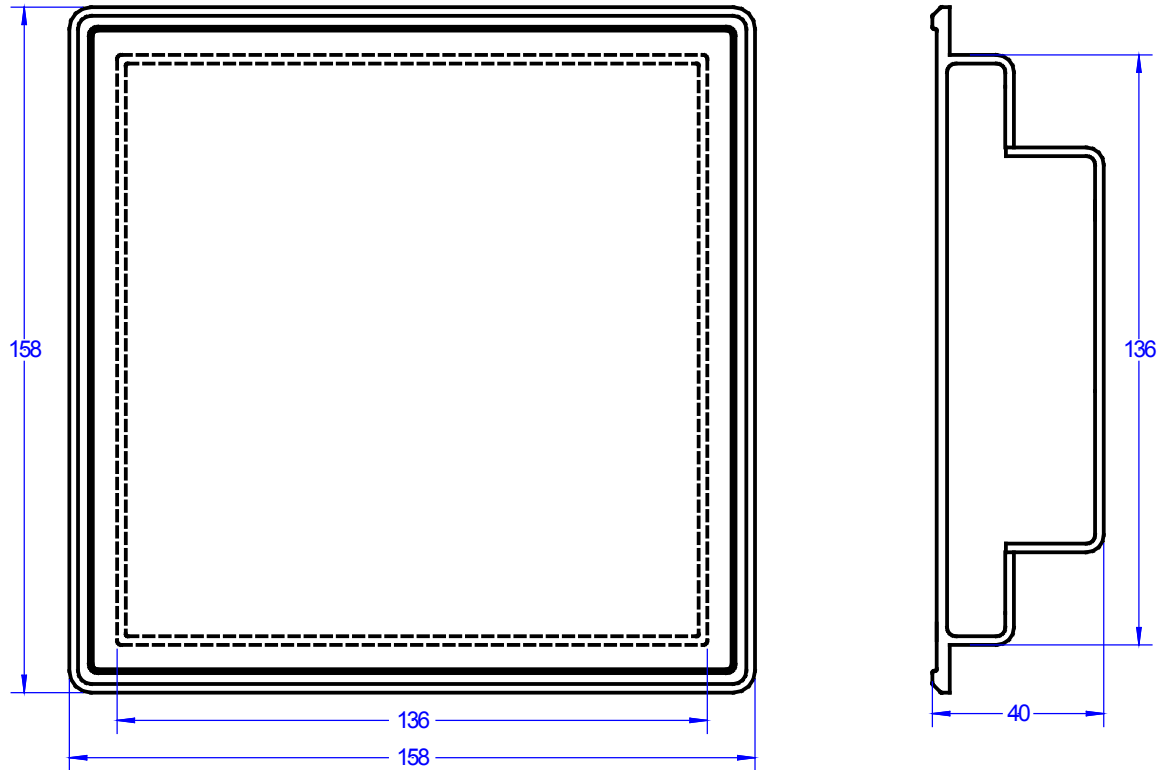

Figure 4-1: Housing - panel cut-out

Description	Dimension	Tolerance
Height	Total	158 mm
	Panel cut-out	138 mm
	Housing dimension	136 mm
Width	Total	158 mm
	Panel cut-out	138 mm
	Housing dimension	136 mm
Depth	Total	40 mm

Table 4-1: Housing - panel cut-out

Installation



For installation into a door panel, proceed as follows:

1. **Panel cut-out**

Cut out the panel according to the dimensions in Figure 4-1.

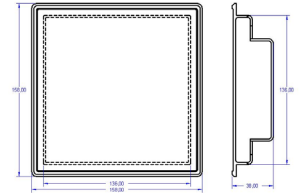

2. **Remove terminals**

Loosen the wire connection terminal screws on the back of the unit and remove the wire connection terminal strips if required (1).

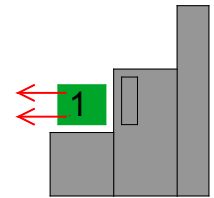

3. **Loosen clamping screws**

Loosen the four clamping screws (1) until they are almost flush with the clamp inserts and tilt the clamp inserts down by 45° (2) to remove them from the housing. Do not completely remove the screws from the clamp inserts.

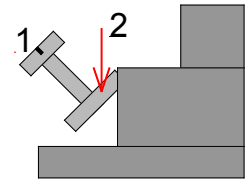

4. **Insert unit into cut-out**

Insert the unit into the panel cut-out. Verify that the unit fits correctly in the cut-out. If the panel cut-out is not big enough, enlarge it accordingly. Ensure that the gasket is placed properly if used. Ensure that the paper strip is not pinched between gasket and panel to maintain isolation.

5. **Attach clamp inserts**

Re-install the clamp inserts by tilting the insert to a 45° angle (1). Insert the nose of the insert into the slot on the side of the housing. Raise the clamp insert so that it is parallel to the control panel (2).

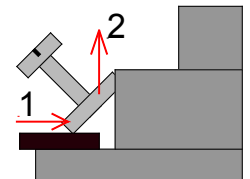

6. **Tighten clamping screws**

Tighten the clamping screws (1) until the control unit is secured to the control panel (2). Over tightening of these screws may result in the clamp inserts or the housing breaking. Do not exceed the recommended tightening torque of 0.1 Nm.

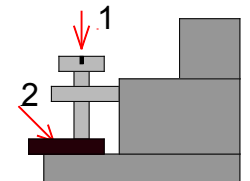

7. **Reattach terminals**

Reattach the wire connection terminal strips (1) and secure them with the side screws.

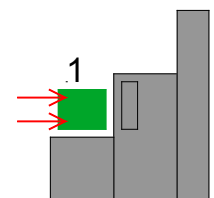

Note: If the gasket is damaged, it needs to be replaced. Use only the original gasket kit (P/N 3050-1057) for replacement.

Chapter 5. Wiring Diagrams

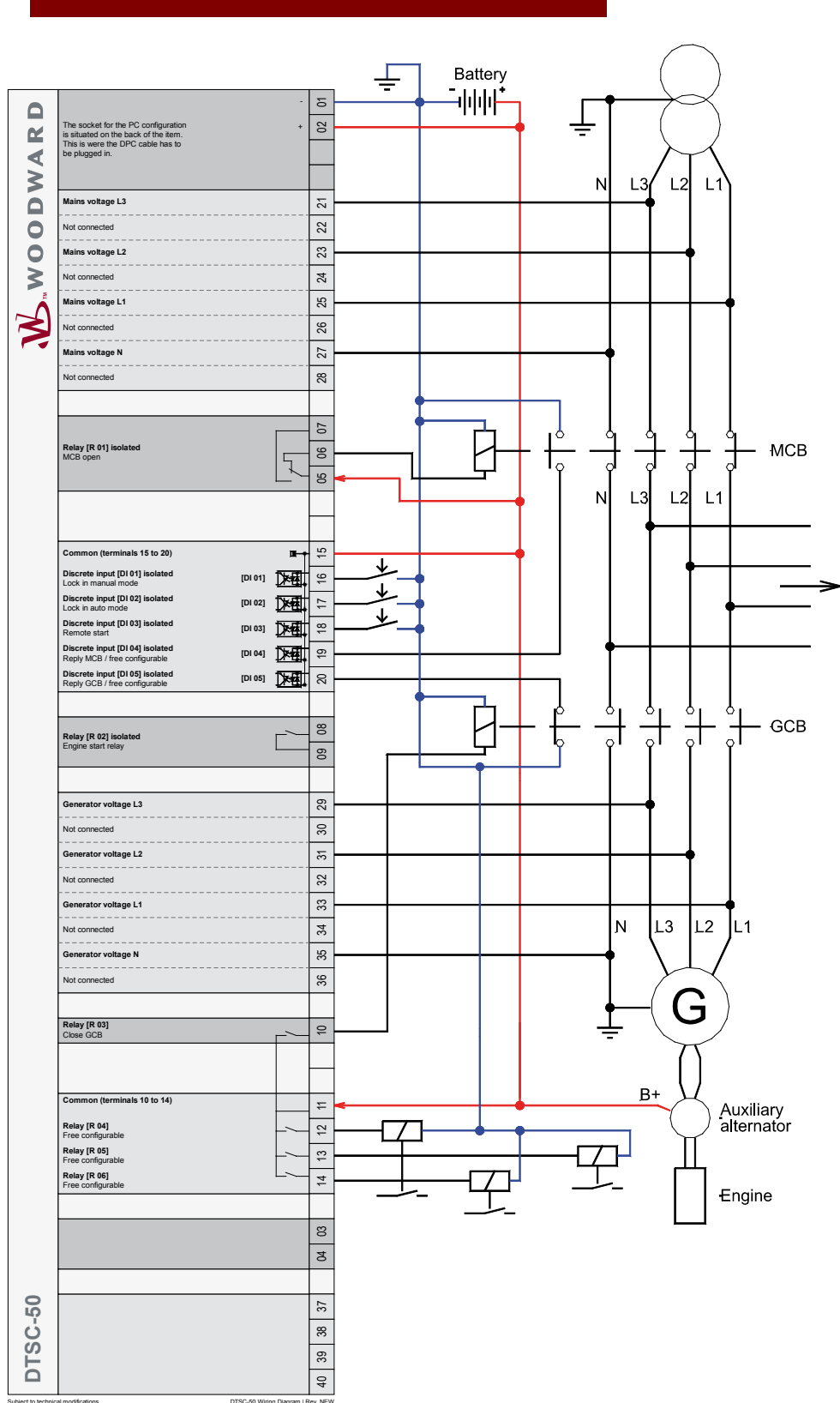

Subject to technical modifications. DTSC-50 Wiring Diagram | Rev. NEW

Figure 5-1: Wiring diagram – DTSC-50

Chapter 6. Connections



NOTE

The wire sizes in the following chapter are indicated in square millimeters. Please refer to Conversion Chart: Wire Size on page 80 to convert the sizes to AWG.

Terminal Arrangement

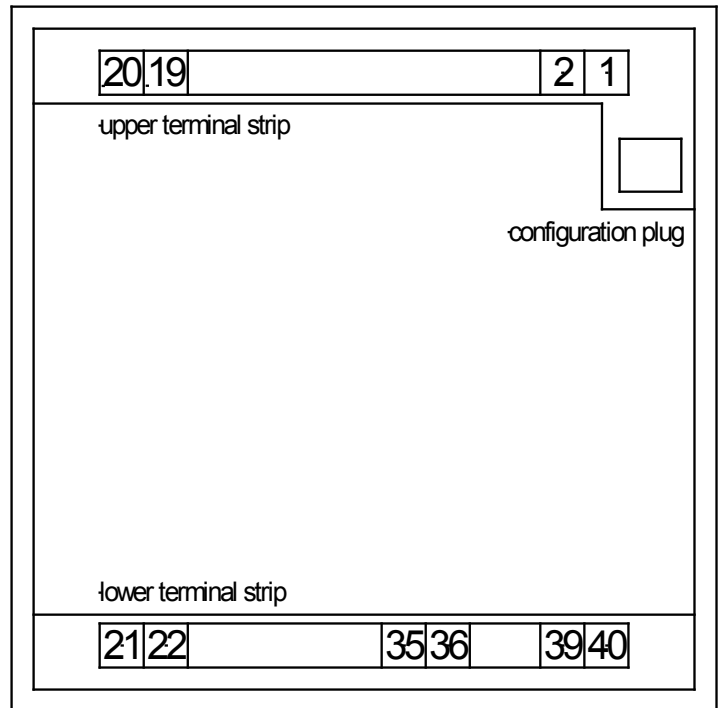

Figure 6-1: DTSC-50 back view - terminal arrangement

Power supply

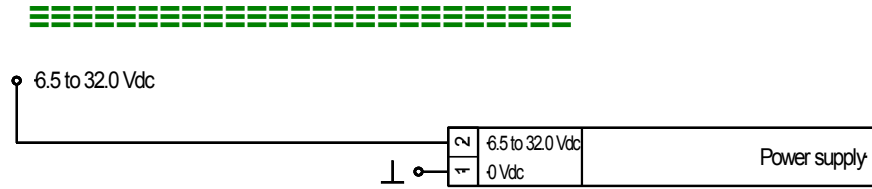

Figure 6-2: Power supply

Terminal	Description	A _{max}
1	0 Vdc reference potential	2.5 mm ²
2	6.5 to 32.0 Vdc	2.5 mm ²

Table 6-1: Power supply - terminal assignment

For a proper operation of the device, a minimum initial voltage of 10.5 Vdc is necessary when switching on the DTSC. After this, a continuous operating voltage between 6.5 and 32 Vdc is possible to operate the DTSC-50 safely. The control unit is capable of handling voltage drops to 0 V for a maximum of 10 ms.



CAUTION

Ensure that the engine will be shut down by an external device in case the power supply of the DTSC-50 control unit fails. Failure to do so may result in damages to the equipment.

Voltage Measuring



The DTSC-50 allows the use of different voltage measuring methods for generator and mains voltage depending on the model. These are described in the following text.

Measuring method	Description
3Ph 4W	Measurement is performed phase-neutral (WYE connected system). Phase voltages and neutral conductor must be connected for proper calculation. The measurement, display and protection are adjusted according to the rules for WYE or delta connected systems. Monitoring refers to the following voltages: <ul style="list-style-type: none"> • V_{L12}, V_{L23}, and V_{L31}, or • V_{L1N}, V_{L2N}, and V_{L3N}.
3Ph 3W	Measurement is performed phase-phase (delta connected system). Phase voltages must be connected for proper calculation. The measurement, display and protection are adjusted according to the rules for delta connected systems. Monitoring refers to the following voltages: <ul style="list-style-type: none"> • V_{L12}, V_{L23}, V_{L31}.
1Ph 2W	Measurement is performed for single-phase systems. The measurement, display and protection are adjusted according to the rules for single-phase systems. Monitoring refers to the following voltages: <ul style="list-style-type: none"> • V_{L1N}.
1Ph 3W	Measurement is performed for single-phase systems. The measurement, display and protection are adjusted according to the rules for single-phase systems. Monitoring refers to the following voltages: <ul style="list-style-type: none"> • V_{L1N}, V_{L3N}.

Table 6-2: Voltage measuring principles

The above described voltage measuring methods are shown with appropriate wiring examples for the different models for generator and mains voltage measuring in Figure 6-3 to Figure 6-11.



NOTE

LeoPC1 and a DPC cable (Revision B, P/N 5417-557) are required to configure the voltage measuring methods “1Ph2W”, “1Ph3W”, “3Ph3W” and “3Ph4W”

Voltage Measuring: Generator

Voltage Measuring: Generator 3Ph 4W

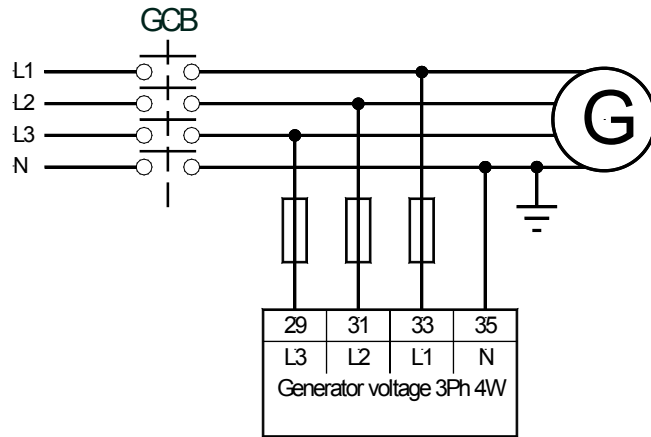

Figure 6-3: Voltage measuring - generator 3Ph 4W

Voltage Measuring: Generator 3Ph 3W

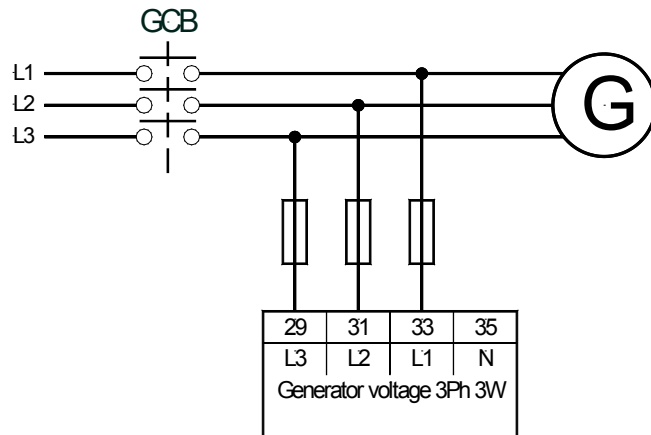

Figure 6-4: Voltage measuring - generator 3Ph 3W

Voltage Measuring: Generator 1Ph 3W

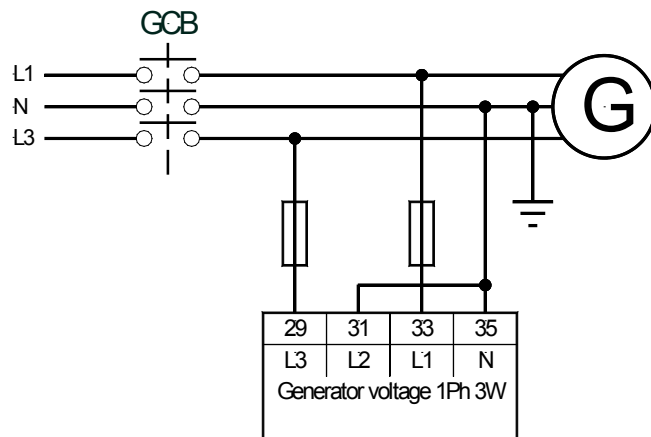

Figure 6-5: Voltage measuring - generator 1Ph 3W

Voltage Measuring: Generator 1Ph 2W

Phase-Neutral Voltage Measuring

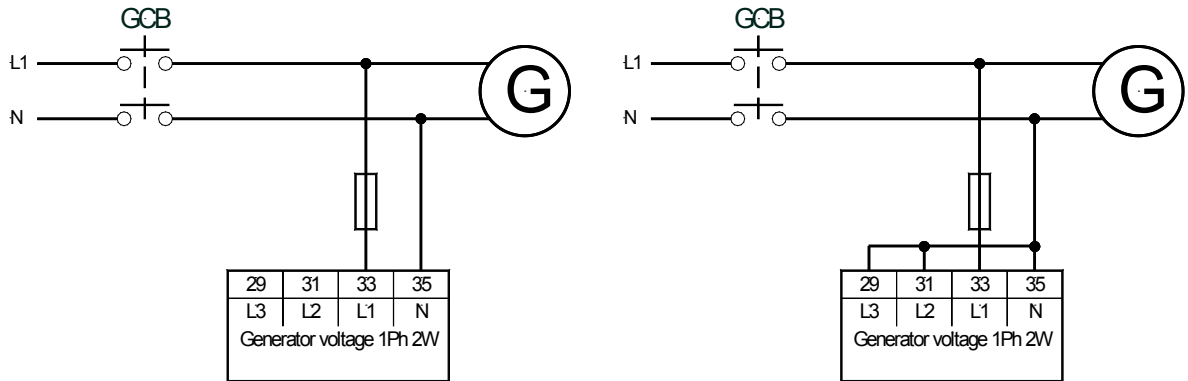

Figure 6-6: Voltage measuring - generator 1Ph 2W, phase-neutral

Phase-Phase Voltage Measuring

It is also possible to perform a phase-phase voltage measuring. The units is intended for a phase-neutral measuring as described above, but may also be used for phase-phase voltage measuring. In this case, phase L2 must be connected to the N terminal of the DTSC-50 and the Generator rated voltage (Parameter 11) must be configured to the phase-phase voltage.

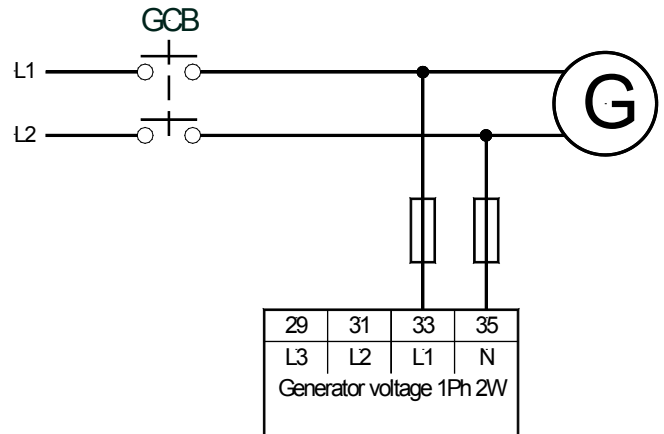

Figure 6-7: Voltage measuring - generator 1Ph 2W, phase-phase

Terminal	Description		A _{max}
29	Generator voltage - phase L3	480 Vac	2.5 mm ²
31	Generator voltage - phase L2	480 Vac	2.5 mm ²
33	Generator voltage - phase L1	480 Vac	2.5 mm ²
35	Generator voltage - phase N	480 Vac	2.5 mm ²

Table 6-3: Voltage measuring - terminal assignment - generator voltage



NOTE

If you select to perform a phase-phase voltage measuring, the display is still indicating a phase-neutral voltage since the voltage is measured between terminal 33 (L1) and 35 (N).

However, if the Generator rated voltage (Parameter 11) is configured correctly, the displayed value is the correct phase-phase voltage value.

Voltage Measuring: Mains

Voltage Measuring: Mains 3Ph 4W

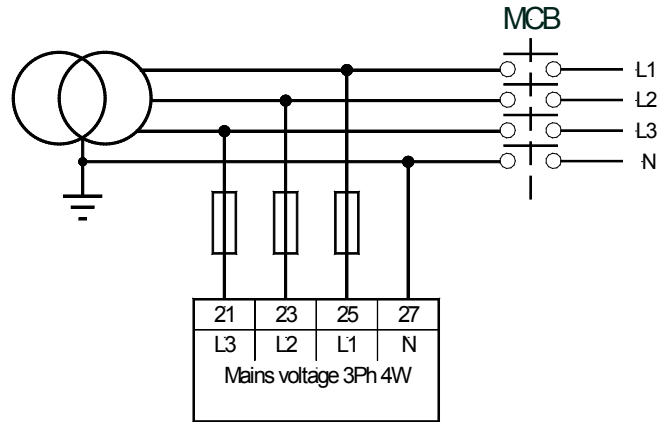

Figure 6-8: Voltage measuring - mains 3Ph 4W

Voltage Measuring: Mains 3Ph 3W

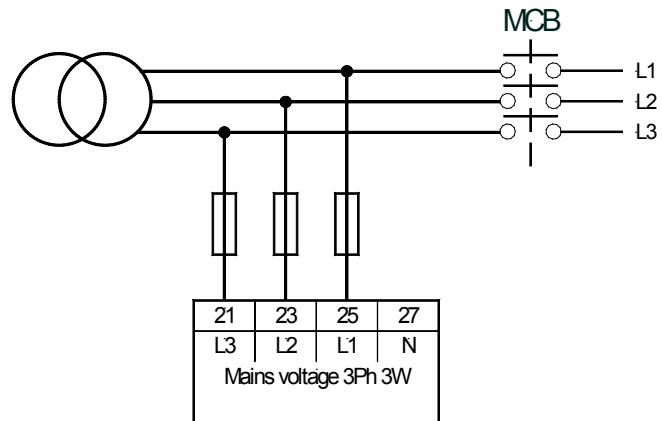

Figure 6-9: Voltage measuring - mains 3Ph 3W

Voltage Measuring: Mains 1Ph 3W

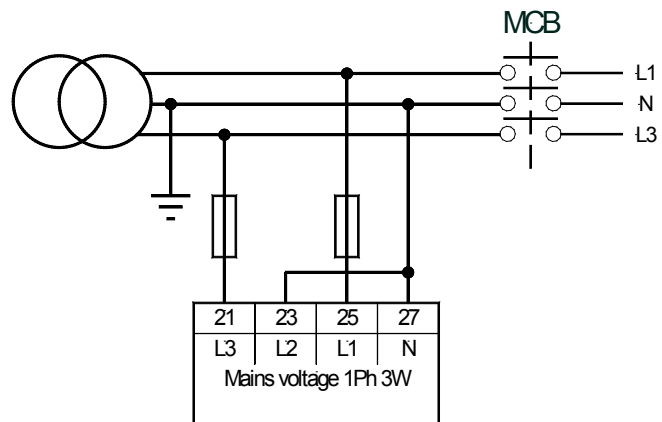

Figure 6-10: Voltage measuring - mains 1Ph 3W

Voltage Measuring: Mains 1Ph 2W

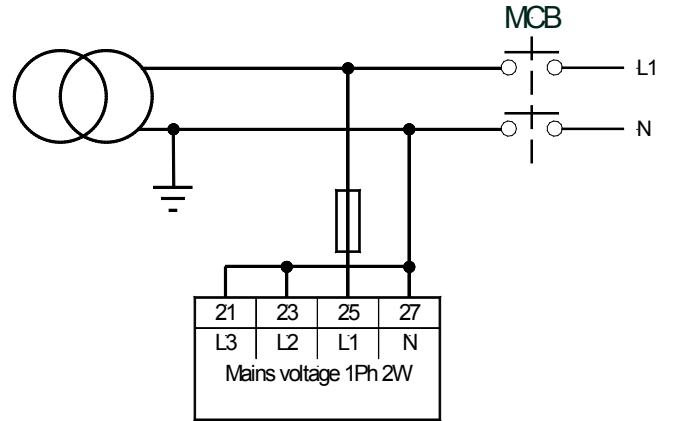

Figure 6-11: Voltage measuring - mains 1Ph 2W

Terminal	Description		A_{max}
21	Mains voltage - phase L3	480 Vac	2.5 mm ²
23	Mains voltage - phase L2	480 Vac	2.5 mm ²
25	Mains voltage - phase L1	480 Vac	2.5 mm ²
27	Mains voltage - phase N	480 Vac	2.5 mm ²

Table 6-4: Voltage measuring - terminal assignment - mains voltage

Discrete Inputs



Discrete Inputs: Bipolar Signals

The discrete inputs are galvanically isolated allowing for a bipolar connection. The discrete inputs are able to handle positive or negative signals.

NOTE All discrete inputs must use the same polarity, either positive or negative signals, due to the common ground.

Discrete Inputs: Positive Signal

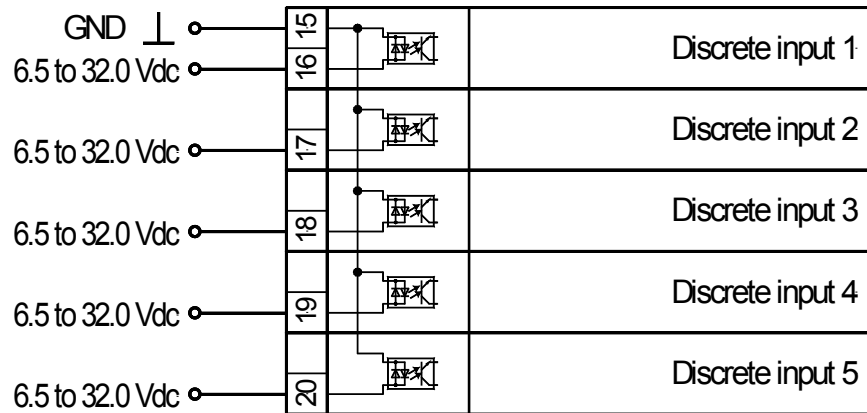

Figure 6-12: Discrete inputs - alarm/control input - positive signal

Terminal Term.	Com.	Description	Type ↕	A _{max}
16	15	Discrete input [D1] Manual Mode	fixed	2.5 mm ²
17		Discrete input [D2] Auto Mode	fixed	2.5 mm ²
18		Discrete input [D3] Remote start	fixed	2.5 mm ²
19		Discrete input [D4] Reply MCB or alarm input	SW	2.5 mm ²
20		Discrete input [D5] Reply GCB or alarm input	SW	2.5 mm ²

SW..alarm input switchable via software, if parameter "Ignore CB reply" is set to "YES"

Table 6-5: Discrete input - terminal assignment - alarm/control input - positive signal

NOTE The parameter "Ignore CB reply" (described on page 54) can only be configured via LeoPC1.

Discrete Inputs: Negative Signal

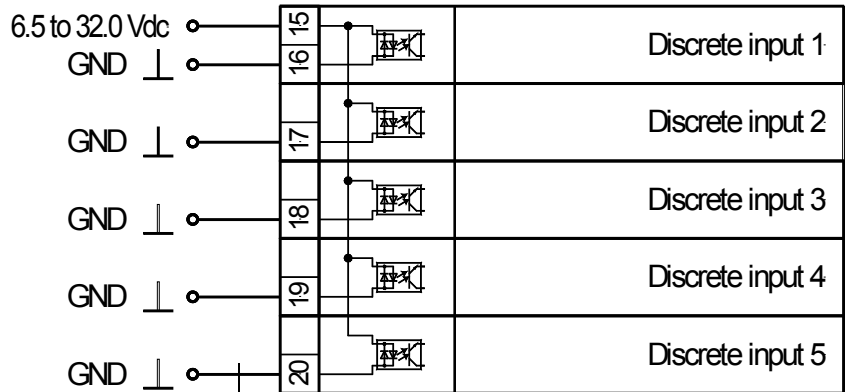

Figure 6-13: Discrete inputs - alarm/control input - negative signal

Terminal Com.	Term.	Description	Type ↕	A _{max}
15	16	Discrete input [D1] Manual Mode	fixed	2.5 mm ²
	17	Discrete input [D2] Auto Mode	fixed	2.5 mm ²
	18	Discrete input [D3] Remote start	fixed	2.5 mm ²
	19	Discrete input [D4] Reply MCB or alarm input	SW	2.5 mm ²
	20	Discrete input [D5] - Reply GCB or alarm input	SW	2.5 mm ²

SW..alarm input switchable via software, if parameter "Ignore CB reply" is set to "YES"

Table 6-6: Discrete input - terminal assignment - alarm/control inputs - negative signal

Discrete Inputs: Operation Logic

Discrete inputs may be configured to be used for normally open (N.O) and normally closed (N.C.) contacts. The default condition for N.O. is that the voltage signal is low. If the N.O. contact closes, the signal becomes high and the DTSC-50 will detect an appropriate alarm or status. The default condition for N.C. is that the voltage signal is high. If the N.C. contact opens, the signal becomes low and the DTSC-50 will detect an appropriate alarm or status.

The N.O. or N.C. contacts may be connected to the signal terminal or to the ground terminal of the discrete input. See previous chapter Discrete Inputs: Bipolar Signals on page 22 for details.

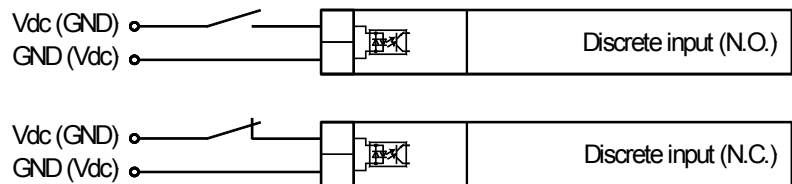

Figure 6-14: Discrete inputs - alarm/control inputs - operation logic

For the DTSC-50, the discrete inputs 1-3 are configured to a factory default and cannot be changed. The discrete inputs 4 and 5 are freely configurable depending on the parameter "Ignore CB reply". If this parameter is set to "YES", the discrete inputs are freely configurable, and the operation logic may be configured either to N.O. or N.C.



NOTE

The parameter "Ignore CB reply" (described on page 54) may only be configured via LeoPC1.

Relay Outputs



The DTSC-50 provides up to six (6) galvanically isolated relay outputs. Some relay outputs have fixed assignments and cannot be configured.

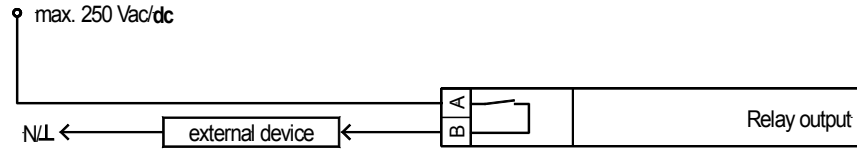

Figure 6-15: Relay outputs

Terminal Term.		Com.		Description		A _{max}
A	B				Type ↕	
5/6	7	Relay output [R1]	Command: open MCB	fixed		2.5 mm ²
8	9	Relay output [R2]	Engine Start	fixed		2.5 mm ²
10	11	Relay output [R3]	Close GCB			2.5 mm ²
12	11	Relay output [R4]	Free Configurable	SW		2.5 mm ²
13	11	Relay output [R5]	Free Configurable	SW		2.5 mm ²
14	11	Relay output [R6]	Free Configurable	SW		2.5 mm ²

Table 6-7: Relay outputs - terminal assignment, part 1

The conditions, which can be assigned to the relay outputs R4, R5 and R6 are listed in Table 10-1: Relay outputs - list of configurable parameters on page 69 (refer to Relay Outputs on page 68).

Interfaces



Overview

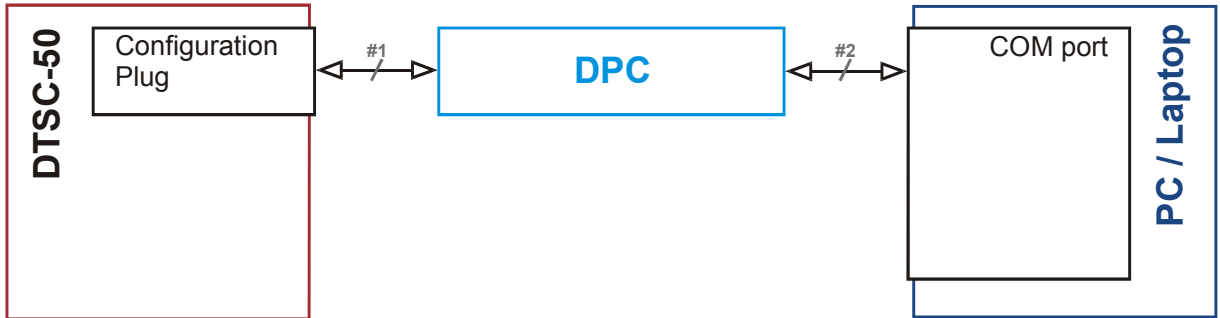

Figure 6-16: Interfaces - overview

No.	Connection from ...	to ...
#1	DTSC-50 [DPC connector]	DPC
#2	DPC	PC [COM port]
	PIN 1 -----	PIN 4 (connect with PIN 8)
	PIN 2 -----	PIN 3
	PIN 3 -----	PIN 2
	PIN 4 -----	PIN 1
	PIN 5 -----	PIN 5
	N/A -----	N/A
	PIN 7 -----	PIN 8 (connect with PIN 4)
	PIN 8 -----	PIN 7
	PIN 9 -----	PIN 9
		Connect PIN4/8

Table 6-8: Interfaces - connection overview



NOTE

The DPC cable (P/N 5417-557) is intended for service operation only. Do not operate the DTSC-50 with the DPC plugged into the unit during regular operation.

DPC - Direct Configuration Cable

 **NOTE**
Please note that the configuration via the direct configuration cable DPC (P/N 5417-557) is possible starting with Revision B (first delivered July 2003). If you have an older model please contact technical sales.

 **NOTE**
The connection cables delivered with the DPC must be used to connect between the control unit and the computer to ensure a proper function of the DTSC-50. Utilization of an extension or different cable types for the connection between DTSC and DPC can result in a malfunction of the DTSC-50. This may possibly result in damage to components of the system. If an extension of the data connection line is required, only the serial cable between DPC and notebook/PC may be extended.
Unplug the DPC after configuration to ensure a safe operation!

Chapter 7. Operation and Navigation

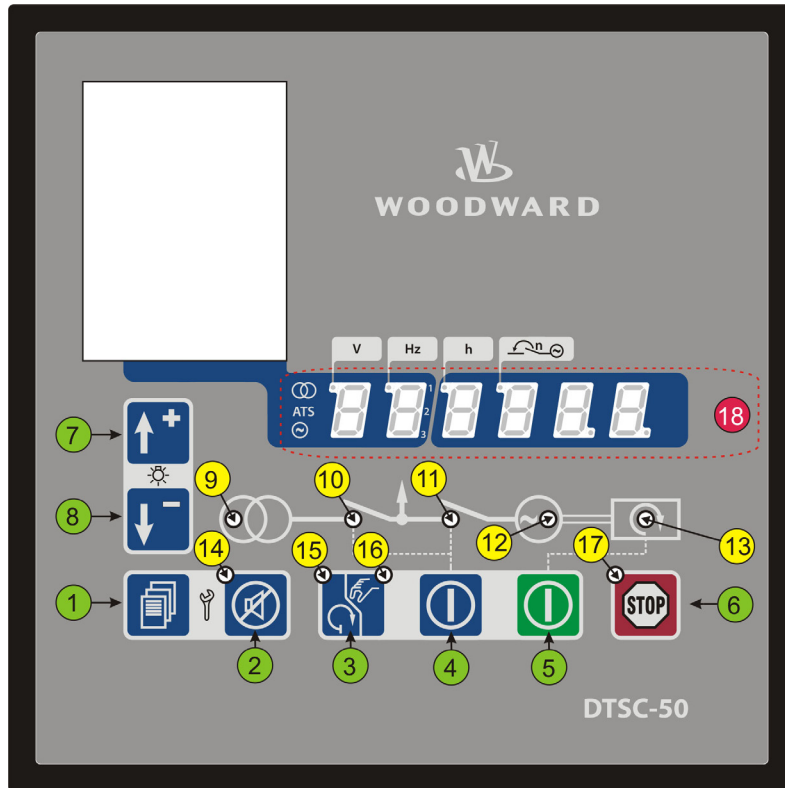

Figure 7-1: Front panel and display

Figure 7-1 illustrates the front panel/display which includes push-buttons, LEDs and the alphanumerical 7 segment LED display. A short description of the front panel is given below.



NOTE



This push-button is **ALWAYS** enabled and will stop the engine when pressed.

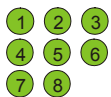

Push-buttons

The push buttons on the front panel are assigned to fixed functions of the unit.

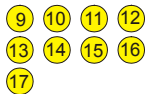

LEDs

The LEDs indicate operating states of the unit and alarm messages. The right LED indicates that alarm messages are present in the unit.



7 segment LED display













This alphanumerical display is used to display all measured values, operating parameters, and alarm messages. A description of this display is detailed later in this manual.



Operation and Display



















Purpose of the Status LEDs

The DTSC-50 has several status LEDs to indicate the operating state. The LEDs indicate the following conditions:



- LED  (on): Mains voltage present
- LED  (flashing): Mains voltage and/or frequency are not within the (see page 47)
- LED : Mains circuit breaker (MCB) closed
- LED : Generator circuit breaker (GCB) closed
- LED  (on): Generator in operation
- LED  (flashing): Generator voltage and/or frequency are not within the (see page 47)
- LED  (on): Engine in operation
- LED  (flashing): Engine in operation, but engine monitoring delay time (see page 55) not yet expired
- LED : Alarm message present
- LED : DTSC-50 in automatic operation mode
- LED : DTSC-50 in manual operation mode
- LED : DTSC-50 in stop operation mode









A function test of all LEDs and the seven-segment display may be conducted by pressing the   and   buttons simultaneously.

Operating the DTSC-50









- When the DTSC-50 control unit is powered up and the genset is not operating, LED  is illuminated and the MCB is closed
- The control unit may be started in automatic mode or have the operation mode changed from automatic to manual by pressing the Auto - Manual button  . LED  (automatic) or LED  (manual) will indicate the current mode of operation by the corresponding LED being illuminated.
- The Breaker Control button   enables the operator to open or close the circuit breaker(s) depending on the current state of the breaker and the control unit being in manual operation mode. This button is disabled in automatic operation mode.
- The Start Engine button   will start the engine when the control unit is in manual operation mode. This button is disabled when the control unit is in automatic operation mode.
- The Stop button   is only enabled if Manual Mode or Automatic mode is NOT selected via the discrete inputs (Terminals 16 and 17).If it is pressed while in automatic mode the engine will be shut down after the configured cool down period has expired. Pressing this button twice will shutdown the genset immediately.
- Active alarm messages may be acknowledged with the Alarm button  . Alarm conditions are indicated when LED  is illuminated.
- When the DTSC-50 is in normal operation, the operator may view the monitored parameters by using the Scroll button  . The monitored values will be displayed on the 7-segment display  (a detailed description of the displayed operating values may be found later in this manual).

Acknowledging Alarm Messages

LED  will flash when an alarm is active. The alarm message will be displayed in the 7-segment display .

Pressing the alarm button   will acknowledge the alarm, reset the alarm relay (if relay is configured for alarm input), and the LED will change from flashing to continuously illuminated. If more than one fault condition is present, the operator may display these messages by pressing the Scroll button  . The alarm may be deleted by pressing and holding the Alarm button   a second time until the LED  is no longer illuminated. If the fault condition is still present, the LED  will remain illuminated and the unit stays in a locked mode according to the appropriate alarm condition.

Configuring the DTSC-50

To enter the configuration mode, press the Scroll  ① and Alarm  ② buttons simultaneously. Only the parameters **00** - HMI Password, **01** - Time until horn reset and **72** - Display level are visible without entering a password. In order to display the other parameters, the correct password must be entered in the Parameter **00** - HMI Password. Pressing the Scroll button  ① will display the various parameters that may be changed. The displayed values for the parameters may be changed by pressing the  ⑦ and  ⑧ buttons (a detailed description of the parameters begins on page 52 of this manual). If the operator presses and holds these buttons, the rate of change for the value will increase. After the parameter has been adjusted to the desired value, enter it into the control unit by pressing the Scroll button  ① once. After a parameter has been changed and entered into the control unit, the operator may advance to the next parameters by pressing the Scroll button  ① a second time. To exit the configuration mode, press the Scroll  ① and Alarm  ② buttons simultaneously again.

Display of the Operating Values

You may advance through the single value displays using the Scroll button  ①.

The values are displayed numerically, while the engineering unit, source, and phase are coded in the seven-segment display  if applicable. See the example below:

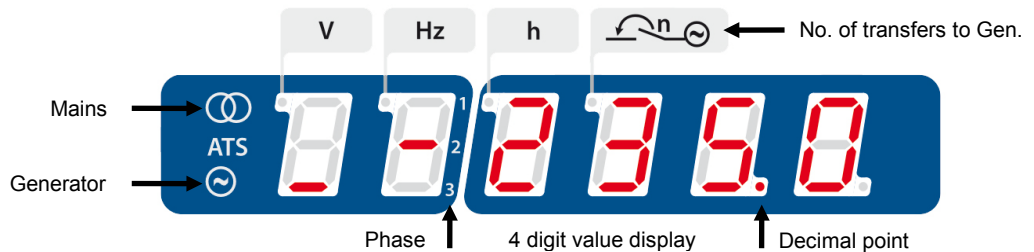

Figure 7-2: 6 digit 7 segment LED display

- The first digit (counted from left) indicates what is being measured, (mains, ATS or generator). The top horizontal segment indicates mains, the middle horizontal segment indicates engine, and the bottom horizontal segment indicates generator.
- The second digit indicates the measured phase. The top segment indicates L1, the middle horizontal segment indicates L2, and the bottom horizontal segment indicates L3. If only one line is displayed for phase measurement, a phase to neutral measurement is displayed. If two lines are displayed, a phase to phase measurement is shown.
- Digits 3-6 indicate what the measured value of the displayed parameter is.
- The indicators located at the top left of the first four digits of the display indicate the engineering unit of measure to be utilized. The indicators are assigned the following engineering units of measure.
 - Digit 1: Volts [V]
 - Digit 2: Frequency [Hz]
 - Digit 3: Operating Hours [h]
 - Digit 4: Number of Transfers to Gen.

With this information, the example in the figure above reads as follows:

Voltage at generator between phase L2 and N is at 235.0 volts

Digit 1: Generator

Digit 2: Measurement between phase L2 and N

Digits 3 to 6: Numerical value 235.0

Indicator at digit 4: Voltage [V]

Digits 5 and 6 of the display are used to display eight different alarm states. The upper and lower vertical segments are used to indicate the various alarm states. Refer to on page 33 for the description of the alarm messages.

For customization of your DTSC-50 front using the paper strips, refer to Front Customization on page 81.

Default Operating Value Display

The DTSC-50 detects and selects the default operating value display by evaluating the measured voltage and the circuit breaker position. This default operating value is always displayed first. The operator may advance through the following operating parameters using the Scroll button  1.

Voltage and CB position	Voltage measuring	Default operating value
Generator voltage present	1Ph 2W or 1Ph 3W	Generator voltage V_{1N}
GCB is closed	3Ph 3W or 3Ph 4W	Generator voltage V_{12}
Mains voltage present	1Ph 2W or 1Ph 3W	Mains voltage V_{1N}
MCB is closed	3Ph 3W or 3Ph 4W	Mains voltage V_{12}

Table 7-1: Display - default operating value

If none of the conditions in Table 7-1 is fulfilled, the generator voltage V_{12} is displayed according to the order in Table 7-2.



NOTE

The operating value display depends on the set display level (refer to Parameter 72 on page 72).

Cycling Through the Displayed Operating Values

If the DTSC-50 is in normal operation, the default operating value is displayed. The operator may advance through the different operating parameters using the Scroll button  1. Following the default operating value, the parameters are displayed in the order shown below (some parameters will not display if the related function is disabled or not available on the control unit):

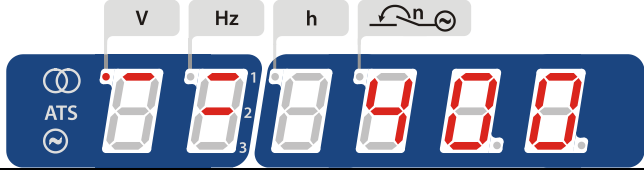
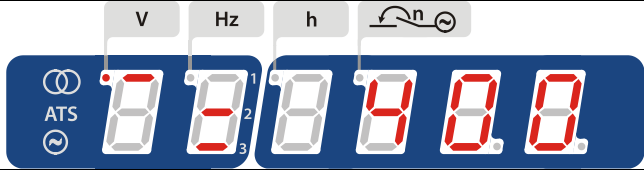
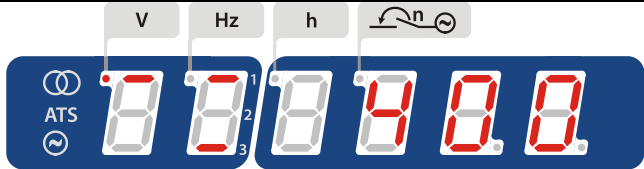
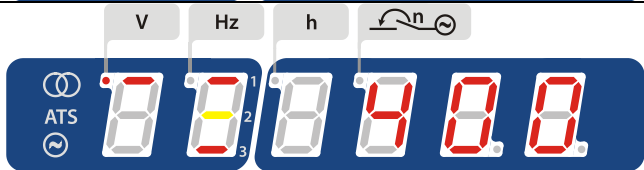
Parameter / display level	Display
Mains voltage V_{12} (phase-phase) DL 1	
Mains voltage V_{23} (phase-phase) DL 2	
Mains voltage V_{31} (phase-phase) DL 2	
Mains voltage Average of the phase-phase voltages (two of the three phase indicators are displayed alternately)	

<p>Mains voltage V_{1N} (phase-neutral)</p> <p>DL 1</p>	
<p>Mains voltage V_{2N} (phase-neutral)</p> <p>DL 2</p>	
<p>Mains voltage V_{3N} (phase-neutral)</p> <p>DL 2</p>	
<p>Mains voltage Average of the phase voltages (one of the three phase indicators is displayed alternately)</p> <p>DL 2</p>	
<p>Rated mains frequency</p> <p>DL 1</p>	
<p>Generator voltage V_{12} (phase-phase)</p> <p>DL 1</p>	
<p>Generator voltage V_{23} (phase-phase)</p> <p>DL 2</p>	
<p>Generator voltage V_{31} (phase-phase)</p> <p>DL 2</p>	
<p>Generator voltage Average of the phase-phase voltages (two of the three phase-phase indicators are displayed alternately)</p> <p>DL 2</p>	

Generator voltage V _{IN} (phase-neutral) DL 1	
Generator voltage V _{2N} (phase-neutral) DL 2	
Generator voltage V _{3N} (phase-neutral) DL 2	
Generator voltage Average of the phase voltages (one of the three phase indicators is displayed alternately) DL 1	
Rated generator frequency DL 1	
Operating hours counter (display is six-digit with one dec- imal) DL 1	
Hours to next maintenance (a negative value indicates excess hours, maintenance overdue) DL 2	
Number of transfers to generator DL 2	
Battery voltage DL 2	

Table 7-2: Display of operating values

If the Scroll button  1 is pressed again, the display returns to the default operating value (refer to Default Operating Value Display on page 30). The display automatically returns after 180 seconds to the default operating value being displayed if a button isn't pressed.





Alarm Messages

If the DTSC-50 detects a fault condition, LED 14 starts to flash. The alarm message is displayed in the seven-segment display 18 with a blinking "A" for alarm, an alarm number. The alarm may be acknowledged by pressing the Alarm button 2. The flashing LED and "A" will change to a continuously illuminated state and the relay will be reset. If more alarm conditions are present, the operator may advance through the different alarm messages using the Scroll button 1. By pressing the Alarm button 2 again, the alarm may be cleared unless the fault condition is still present.

Class	Description	Reaction of the system
B	Alarm	The operation is not interrupted but a centralized alarm is issued.
F	Shutdown	The GCB will be opened immediately and the engine will be stopped without cool down.

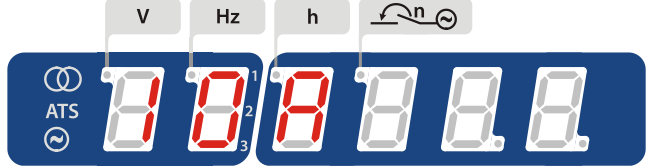
Table 7-3: Alarm classes

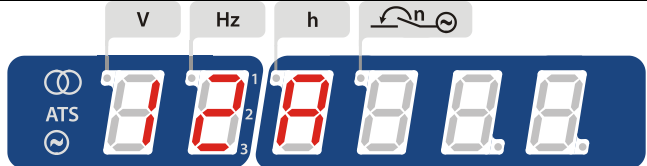
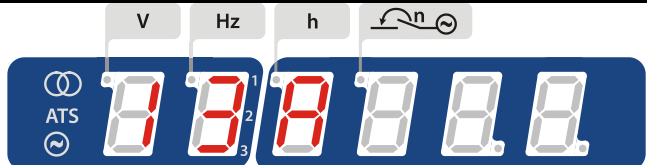
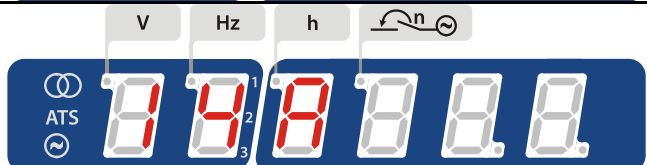
The following table displays the possible alarm messages:

Alarm	Alarm class	Display
10 Generator overfrequency	B: Alarm	
11 Generator underfrequency	B: Alarm	
12 Generator overvoltage	B: Alarm	
13 Generator undervoltage	B: Alarm	
14 Mains rotation field mismatch	B: Alarm	
30 Start fail	B: Alarm	
31 Unintended stop	B: Alarm	

Alarm	Alarm class	Display
40 Maintenance hours	B: Alarm	
51 Generator breaker close failure	B: Alarm	
52 Generator breaker open failure	B: Alarm	
53 Mains breaker close failure	B: Alarm	
54 Mains breaker open failure	B: Alarm	
62 DI4: MCB reply or free configurable	Control input/ Selectable B or F	
63 DI5: GCB reply or free configurable	Control input/ Selectable B or F	

Table 7-4: Alarm messages

i **NOTE**
Discrete Inputs 4 & 5: If the parameter "Ignore Breaker Replies" (only changeable via LeoPC1) is set to "YES", the discrete inputs for 4 and 5 are no longer control inputs. These discrete inputs may now be used as freely configurable alarm inputs. All alarm classes may be configured for these discrete inputs.

Configuration Displays

The following parameters can be configured as described under Configuring the on page 29:

	Parameter	Range	Display
DL 1	00 HMI Password	0000 to 9999	
DL 1	01 Time until horn reset	0 to 1000 s [1 s interval]	
DL 3	10 Rated frequency	50 Hz, 60 Hz	
DL 3	11 Generator rated voltage	50 to 480 V [1 V interval]	
DL 3	12 Mains rated voltage	50 to 480 V [1 V interval]	
DL 3	40 Cooldown time	0 to 999 s [1 s interval]	
DL 3	50 Generator over-frequency threshold	50.0 to 130.0 % [0.1 % interval]	
DL 3	51 Generator over-frequency delay time	0.1 to 99.9 s [0.1 s interval]	
DL 3	52 Generator under-frequency threshold	50.0 to 130.0 % [0.1 % interval]	

<p>53 DL 3</p>	<p>Generator un- derfrequency delay time</p>	<p>0.1 to 99.9 s [0.1 s interval]</p>	<p>The display shows '99.9' in red LEDs. Above the digits are labels 'V', 'Hz', and 'h'. To the right is a hand icon with a circular arrow. On the left, there are icons for 'ATS' and a sine wave.</p>
<p>54 DL 3</p>	<p>Generator overvoltage threshold</p>	<p>50.0 to 125.0 % [0.1 % interval]</p>	<p>The display shows '50.0' in red LEDs. Above the digits are labels 'V', 'Hz', and 'h'. To the right is a hand icon with a circular arrow. On the left, there are icons for 'ATS' and a sine wave.</p>
<p>55 DL 3</p>	<p>Generator overvoltage de- lay time</p>	<p>0.1 to 99.9 s [0.1 s interval]</p>	<p>The display shows '99.9' in red LEDs. Above the digits are labels 'V', 'Hz', and 'h'. To the right is a hand icon with a circular arrow. On the left, there are icons for 'ATS' and a sine wave.</p>
<p>56 DL 3</p>	<p>Generator un- dervoltage thre- shold</p>	<p>50.0 to 125.0 % [0.1 % interval]</p>	<p>The display shows '50.0' in red LEDs. Above the digits are labels 'V', 'Hz', and 'h'. To the right is a hand icon with a circular arrow. On the left, there are icons for 'ATS' and a sine wave.</p>
<p>57 DL 3</p>	<p>Generator un- dervoltage de- lay time</p>	<p>0.1 to 99.9 s [0.1 s interval]</p>	<p>The display shows '99.9' in red LEDs. Above the digits are labels 'V', 'Hz', and 'h'. To the right is a hand icon with a circular arrow. On the left, there are icons for 'ATS' and a sine wave.</p>
<p>70 DL 1</p>	<p>Maintenance hours</p>	<p>0 to 9999 h [1 h interval]</p>	<p>The display shows '0000' in red LEDs. Above the digits are labels 'V', 'Hz', and 'h'. To the right is a hand icon with a circular arrow. On the left, there are icons for 'ATS' and a sine wave.</p>
<p>71 DL 1</p>	<p>Reset mainten- ance hours</p>	<p>0 = no, 1 = yes</p>	<p>The display shows '0000' in red LEDs. Above the digits are labels 'V', 'Hz', and 'h'. To the right is a hand icon with a circular arrow. On the left, there are icons for 'ATS' and a sine wave.</p>
<p>72 DL 1</p>	<p>Display level</p>	<p>1, 2, 3</p>	<p>The display shows '123' in red LEDs. Above the digits are labels 'V', 'Hz', and 'h'. To the right is a hand icon with a circular arrow. On the left, there are icons for 'ATS' and a sine wave.</p>
<p>80 DL 3</p>	<p>Mains settling time</p>	<p>0 to 9999 s [1 s interval]</p>	<p>The display shows '0000' in red LEDs. Above the digits are labels 'V', 'Hz', and 'h'. To the right is a hand icon with a circular arrow. On the left, there are icons for 'ATS' and a sine wave.</p>
<p>81 DL 3</p>	<p>Mains overvol- tage threshold</p>	<p>50.0 to 130.0 % [0.1 % interval]</p>	<p>The display shows '50.0' in red LEDs. Above the digits are labels 'V', 'Hz', and 'h'. To the right is a hand icon with a circular arrow. On the left, there are icons for 'ATS' and a sine wave.</p>

82 DL 3	Mains under-voltage threshold	50.0 to 130.0 % [0.1 % interval]	
83 DL 3	Mains voltage hysteresis	0.0 to 50.0 % [0.1 % interval]	
84 DL 3	Mains overfrequency threshold	70.0 to 160.0 % [0.1 % interval]	
85 DL 3	Mains under-frequency threshold	70.0 to 160.0 % [0.1 % interval]	
86 DL 3	Mains frequency hysteresis	0.0 to 50.0 % [0.1 % interval]	
Parameter		Range	Display
87 DL 3	Mains phase rotation monitoring - self acknowledge	0 = Off 1 = On	

Table 7-5: Configuration displays



NOTE

The display automatically returns to the default operating value (refer to Default Operating Value Display on page 30) if a button isn't pressed within 180 seconds.

Display Hierarchy

The display system refreshes if a button isn't pressed within 180 seconds. The initial display depends on the presence of alarm or error messages and the operating mode. The following display hierarchy applies:

Hierarchy level	Display	Comments
	Alarm messages	Alarm messages are displayed first if they are present (refer to Alarm Messages on page 33)
2	Operating values	The operating values are displayed if no alarm or J1939 DM1/DM2 error messages are present in STOP operating mode or no alarm messages are present in MANUAL or AUTOMATIC operating mode (refer to Display of the Operating Values on page 29)

Table 7-6: Display hierarchy

Chapter 8. Functional Description

Overview



Operation Mode	Manual (via Faceplate)	AUTO (via Faceplate)	Manual (via discrete in- put)	Auto (via discrete in- put)
Operate the engine				
• Start engine by:				
the engine START - STOP push button	YES	---	YES	---
the discrete input DI3 (remote start)	---	YES	---	YES
emergency power (AMF)	---	YES	---	YES
• Stop engine by:				
the STOP push button	YES	YES	YES	---
the discrete input DI3 (remote start)	---	YES	---	YES
emergency power (AMF)	---	YES	---	YES
an alarm	---	---	---	---
• Operating mode selection:				
the AUTO/MANUAL push button	YES	YES	---	---
Operate GCB				
• close GCB				
the BREAKER CONTROL push button (only if engine is running)	YES	---	YES	---
emergency power (AMF)	---	YES	---	YES
• open GCB				
the STOP push button	YES	YES	YES	---
the BREAKER CONTROL push button	YES	---	YES	---
emergency power (AMF)	---	YES	---	YES
an alarm (i.e. overvoltage)	YES	YES	YES	YES
Operate MCB				
• open MCB				
the BREAKER CONTROL push button	YES	---	YES	---
emergency power (AMF)	---	YES	---	YES
• close MCB				
the STOP push button	YES	YES	YES	---
the BREAKER CONTROL push button (only if mains are present)	YES	---	YES	---
emergency power (AMF)	---	YES	---	YES

Table 8-1: Functional description - Overview

- **Application Mode** (page Fehler! Textmarke nicht definiert.): depends on the application; defines the number/function of the breakers.
- **Operating Mode** (page 39): depends on the application; differs between STOP, MANUAL and AUTOMATIC modes.

Operating Modes



Operating Mode STOP

Please consider the following :

If the operation modes “Auto” or “Manual” have been selected via discrete inputs, it is not possible to switch the device into operation mode “Stop”.

Selected Operation mode	DTSC-50 will switch to operation mode STOP if “STOP” button is pressed ?
AUTO (via Faceplate)	Yes
Manual (via Faceplate)	Yes
AUTO (via discrete input)	No
Manual (via discrete input)	No



In the STOP operating mode neither the engine or the power circuit breakers can be operated. The following occurs if operating mode STOP has been selected while...

...the engine is not running

1. The GCB will not close
2. “Engine Start” relay will not be set
3. The push buttons START and BREAKER CONTROL are disabled
4. The engine/generator monitoring remains de-activated (exception: all monitoring that is not delayed by the delayed engine speed monitoring)
5. The MCB will be closed if it is open

...the engine is running

1. The GCB will open if it is closed
2. The MCB will close if the GCB is open and mains are present
3. An engine cool down will be performed
4. The “Engine Start” relay is de-energized
5. Selected engine/generator monitoring functions (this includes under-voltage, -frequency) will be de-activated (exception: all monitoring that is not delayed by the delayed engine speed monitoring)

Operating Mode **MANUAL**



NOTE

You find an overview about the buttons, LEDs and the seven-segment display under Operation and Navigation on page 27.



In the MANUAL operating mode (AUTO - MANUAL button 3) the engine and the power circuit breakers are operated via the BREAKER CONTROL button 4. The LED 16 in the upper right corner of the AUTO - MANUAL button 3 indicates the manual operating mode.

You can perform the following actions in the MANUAL operating mode depending on the application mode:



The START button 5
Start the engine (if the engine is stopped, LED 13 is not illuminated)



The BREAKER CONTROL button 4
Open the GCB and close the MCB (if the control unit is in generator operation (LEDs 11 and 12 are illuminated) and mains are present, LED 9 is illuminated)
Open the MCB and close the GCB (if the control unit is in mains operation (LEDs 9 and 10 are illuminated) and engine is running, LED 13 is illuminated)

Detailed operation in MANUAL mode (mains are not present)

- Preconditions:**
- Generator is stopped – LED 12 is not illuminated
 - MCB is closed – LED 10 is illuminated
 - Mains are present – LED 9 is illuminated
 - Unit is in manual mode – LED 16 is illuminated

Engine start sequence:

Action	<i>START</i>	Press the START button 5
Operation	<i>Engine Start relay</i>	The engine start relay (relay 2) is energized to start the engine – LED 12 illuminates and LED 13 starts flashing when generator voltage and frequency has been detected
Delay	<i>Engine delay time</i>	The engine monitoring is delayed until time configured in the engine parameters (page 55) expires – LED 13 changes to steady illumination after the time expires

GCB close sequence:

Delay	<i>Generator settling time</i>	The BREAKER CONTROL button will only be active after this timer has been expired. If this timer is not required by the user, it can be configured to “Zero” Seconds.
Action	<i>Breaker control</i>	Pressing the BREAKER CONTROL button 4
Operation	<i>Open MCB</i>	The MCB open relay (relay 1) energizes to open the MCB – LED 10 goes out
Delay	<i>Breaker delay</i>	The control unit waits for the breaker transfer time configured in the breaker parameters (page 56) to expire
Operation	<i>Close GCB</i>	The GCB close relay (relay 3) energizes to close the GCB – LED 11 illuminates

MCB close sequence:

Action	<i>Breaker control</i>	Press the BREAKER CONTROL button ④
Operation	<i>Open GCB</i>	The GCB close relay (relay 3) de-energizes to open the GCB – LED ⑪ goes out
Delay	<i>Breaker delay</i>	The control unit waits for the breaker transfer time configured in the breaker parameters (page 56) to expire
Operation	<i>Close MCB</i>	The MCB open relay (relay 1) de-energizes to close the MCB – LED ⑩ illuminates

Stop sequence via STOP – BUTTON**(If MANUAL mode is selected via discrete input :**

Action	<i>STOP</i>	Press the STOP - button ⑤
Operation	<i>Open GCB</i>	The GCB close relay (relay 3) de-energizes to open the GCB – LED ⑪ goes out
Operation	<i>Engine stop</i>	The engine stops – LEDs ⑫ and ⑬ go out
Action	<i>Breaker control</i>	Pressing the BREAKER CONTROL button ④
Operation	<i>Close MCB</i>	The MCB open relay (relay 1) de-energizes to close the MCB – LED ⑩ illuminates

Stop sequence via STOP one time:**(If MANUAL mode is selected via Faceplate)**

Action	<i>STOP</i>	Press the STOP button ⑥ once
Operation	<i>Open GCB</i>	The GCB close relay (relay 3) de-energizes to open the GCB – LED ⑪ goes out
Delay	<i>Breaker delay</i>	The control unit waits for the breaker transfer time configured in the breaker parameters (page 56) to expire
Operation	<i>Close MCB</i>	The MCB open relay (relay 1) de-energizes to close the MCB – LED ⑩ illuminates
Delay	<i>Cool down time</i>	The control unit waits for the cool down time configured in the engine parameters (page 55) to expire
Operation	<i>Engine stop</i>	The engine stops – LEDs ⑫ and ⑬ go out

Stop sequence via STOP two times:**(If MANUAL mode is selected via Faceplate)**

Action	<i>STOP</i>	Press the STOP button ⑥ twice
Operation	<i>Open GCB</i>	The GCB close relay (relay 3) de-energizes to open the GCB – LED ⑪ goes out
Delay	<i>Breaker delay</i>	The control unit waits for the breaker transfer time configured in the breaker parameters (page 56) to expire
Operation	<i>Close MCB</i>	The MCB open relay (relay 1) de-energizes to close the MCB – LED ⑩ illuminates
Operation	<i>Engine stop</i>	The engine stops immediately without a cool down period – LEDs ⑫ and ⑬ go out

Detailed operation in MANUAL mode (mains are not present)

- Preconditions:**
- Generator is stopped – LED ⑫ is not illuminated
 - MCB is closed – LED ⑩ is illuminated
 - Mains are not present – LED ⑨ is not illuminated
 - Unit is in manual mode – LED ⑯ is illuminated

Engine start sequence:

Action *START*
 Operation *Engine start relay*
 Delay *Engine delay time*

Press the START button 5
 The engine start relay (relay 2) is energized to engage the starter – LED 12 illuminates and LED 13 starts flashing when generator speed has been detected
 The control unit waits for the engine monitoring delay time configured in the engine parameters (page 55) to expire – LED 13 changes to steady illumination after the time expires

GCB close sequence:

Delay *Generator settling time*
 Action *Breaker control*
 Operation *Open MCB*
 Delay *Breaker delay*
 Operation *Close GCB*

The BREAKER CONTROL button will only be active after this timer has been expired. If this timer is not required by the user, it can be configured to “Zero” Seconds.
 Press the BREAKER CONTROL button 4
 The MCB open relay (relay 1) energizes to open the MCB – LED 10 goes out
 The control unit waits for the breaker transfer time configured in the breaker parameters (page 56) to expire
 The GCB close relay (relay 2) energizes to close the GCB – LED 11 illuminates

GCB open sequence:

Action *Breaker control*
 Operation *Open GCB*

Press the BREAKER CONTROL button 4
 The GCB close relay (relay 3) de-energizes to open the GCB – LED 11 goes out

Note The MCB close command will not be issued unless the mains return

Stop sequence via STOP – BUTTON

(If MANUAL mode is selected via discrete input :

Action *STOP*
 Operation *Open GCB*
 Operation *Engine stop*

Please not that the following description is only valid if MANUAL mode has been selected via discrete input !

Press the STOP button 5
 The GCB close relay (relay 3) de-energizes to open the GCB – LED 11 goes out
 The engine stops – LEDs 12 and 13 go out

Stop sequence via STOP one time: (If MANUAL mode is selected via Faceplate)

Action *STOP*
 Operation *Open GCB*
 Delay *Cool down time*

Please not that the following description is only valid if MANUAL mode has been selected via the faceplate !

Press the STOP button 6 once
 The GCB close relay (relay 3) de-energizes to open the GCB – LED 11 goes out
 The control unit waits for the cool down time configured in the engine parameters (page 55) to expire

Operation *Engine stop*

Stop sequence via STOP two times: (If MANUAL mode is selected via Faceplate)

Action *STOP*
 Operation *Open GCB*
 Operation *Engine stop*

Please not that the following description is only valid if MANUAL mode has been selected via the faceplate !

Press the STOP button 6 twice
 The GCB close relay (relay 3) de-energizes to open the GCB – LED 11 goes out
 The engine stops – LEDs 12 and 13 go out

Operating Mode AUTOMATIC



In the AUTOMATIC operating mode, all engine, GCB, and/or MCB functions are operated via the discrete inputs or automatically by the control unit (i.e. a mains failure). The function of the DTSC-50 depends on the configuration of the unit and how the external signals are used. LED ¹⁵, in the upper left corner of the AUTO - MANUAL button ³, indicates the automatic operating mode.

Detailed operation in automatic mode (mains are present)

- Preconditions:**
- Generator is stopped – LED ¹² is not illuminated
 - MCB is closed – LED ¹⁰ is illuminated
 - Mains are present – LED ⁹ is illuminated
 - Unit is in automatic mode – LED ¹⁵ is illuminated

Start sequence:

Action	<i>Remote start</i>	Discrete input DI3 (remote start) is activated (active HIGH signal) at terminal 18
Operation	<i>Engine start relay</i>	The engine start relay (relay 2) is energized to engage the starter – LED ¹² illuminates and LED ¹³ starts flashing when generator speed has been detected
Delay	<i>Engine delay time</i>	The control unit waits for the engine monitoring delay time configured in the engine parameters (page 55) to expire – LED ¹³ changes to steady illumination after the time expires
Delay	<i>Generator settling time</i>	The MCB will only be opened after this timer has been expired. If this timer is not required by the user, it can be configured to “Zero” Seconds.
Operation	<i>Open MCB</i>	The MCB open relay (relay 1) energizes to open the MCB – LED ¹⁰ goes out
Delay	<i>Breaker delay</i>	The control unit waits for the breaker transfer time configured in the breaker parameters (page 56) to expire
Operation	<i>Close GCB</i>	The GCB close relay (relay 3) energizes to close the GCB – LED ¹¹ illuminates

Stop sequence:

Action	<i>Remote stop</i>	Discrete input DI3 (remote start) is deactivated (active LOW signal) at terminal 18
Operation	<i>Open GCB</i>	The GCB close relay (relay 3) de-energizes to open the GCB – LED ¹¹ goes out
Delay	<i>Breaker delay</i>	The control unit waits for the breaker transfer time configured in the breaker parameters (page 56) to expire
Operation	<i>Close MCB</i>	The MCB open relay (relay 1) de-energizes to close the MCB – LED ¹⁰ illuminates
Delay	<i>Cool down time</i>	The control unit waits for the cool down time configured in the engine parameters (page 55) to expire
Operation	<i>Engine stop</i>	The engine stops – LEDs ¹² and ¹³ go out

Detailed operation in automatic mode (mains are not present)

- Preconditions:**
- Generator is stopped – LED 12 is not illuminated
 - MCB is closed – LED 10 is illuminated
 - Mains are not present – LED 9 is not illuminated
 - Unit is in automatic mode – LED 15 is illuminated

Start sequence:

Action	<i>Remote start</i>	Discrete input DI3 (remote start) is activated (active HIGH signal) at terminal 18
Operation	<i>Engine start relay</i>	The engine start relay (relay 2) is energized to engage the starter – LED 12 illuminates and LED 13 starts flashing when generator speed has been detected
Delay	<i>Engine delay time</i>	The control unit waits for the engine monitoring delay time configured in the engine parameters (page 55) to expire – LED 13 changes to steady illumination after the time expires
Delay	<i>Generator settling time</i>	The MCB will only be opened after this timer has been expired. If this timer is not required by the user, it can be configured to “Zero” Seconds.
Operation	<i>Open MCB</i>	The MCB open relay (relay 1) energizes to open the MCB – LED 10 goes out
Delay	<i>Breaker delay</i>	The control unit waits for the breaker transfer time configured in the breaker parameters (page 56) to expire
Operation	<i>Close GCB</i>	The GCB close relay (relay 3) energizes to close the GCB – LED 11 illuminates

Stop sequence:

Action	<i>Remote stop</i>	Discrete input DI3 (remote start) is deactivated (active LOW signal) at terminal 18.
--------	--------------------	--

The engine will continue to run and the GCB remains closed since Mains is not present !

**NOTE**

If mains fails while the Remote start command (via discrete input 3) is still active, the GCB will remain closed, and the engine start signal will still be kept set ! The remote start Signal is interpreted by the DTSC-50 as “Do not return to the mains source”, therefore no transfer actions will take place.

AMF / Auto Mains Failure Operation

The operation sequence for an AMF operation is similar to the above sequence with the difference that a remote start signal is not required for the engine start and the engine monitoring delay time is not considered, i.e. the CBs are operated immediately. For an AMF operation in automatic mode the parameter Emergency power monitoring (page 57) must be configured to ON, no class F alarms may be present, the engine must be ready for operation, and the configured mains fail delay time (page 57) must expire to start the engine.

Detailed operation in case of a mains failure :

- Preconditions:**
- Generator is stopped – LED 12 is not illuminated
 - MCB is closed – LED 10 is illuminated
 - Mains is present – LED 9 is illuminated
 - Unit is in automatic mode – LED 15 is illuminated

Start sequence:

Action	<i>Mains failure</i>	A mains failure occurred. LED 9 is no longer illuminated
Delay	<i>Mains fail delay time</i>	After the mains failure has been detected, the “Mains fail delay” timer is triggered. If this timer has expired, the DTSC-50 initiates a start signal to start the Engine.
Operation	<i>Engine start relay</i>	The engine start relay (relay 2) is energized to engage the starter – LED 12 illuminates and LED 13 starts flashing when generator speed has been detected
Delay	<i>Engine delay time</i>	The control unit waits for the engine monitoring delay time configured in the engine parameters (page 55) to expire – LED 13 changes to steady illumination after the time expires
Delay	<i>Generator settling time</i>	The MCB will only be opened after this timer has been expired. If this timer is not required by the user, it can be configured to “Zero” Seconds.
Operation	<i>Open MCB</i>	The MCB open relay (relay 1) energizes to open the MCB – LED 10 goes out
Delay	<i>Breaker delay</i>	The control unit waits for the breaker transfer time configured in the breaker parameters (page 56) to expire
Operation	<i>Close GCB</i>	The GCB close relay (relay 3) energizes to close the GCB – LED 11 illuminates

Illustration of transfer sequence in case of a mains failure :

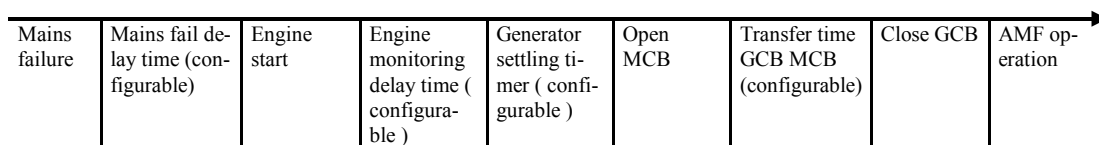

Detailed operation in case of a mains returning :

- Preconditions:**
- Generator is running – LED 12 is illuminated
 - GCB is closed – LED 11 is illuminated
 - Mains not present – LED 9 is not illuminated
 - Unit is in automatic mode – LED 15 is illuminated

Re-Transfer sequence:

Action	<i>Mains returns</i>	Mains returns. LED 9 starts flashing
Delay	<i>Mains settling time</i>	After the “Mains settling timer” has been expired LED 9 is illuminated constantly. The mains is now considered to be stable for a re-transfer.



The DTSC-50 provides a special parameter called “Bypass mains settling timer on Genset failure” that can be configured by the user. If this parameter is configured to “YES” the “Mains settling timer” is automatically bypassed if the “Mains settling timer” is timing and the Genset has failed.

If the “Bypass mains settling timer ...” parameter is configured to “NO”, then the “Mains settling timer” has to expired completely until a re-transfer is being initiated.

Operation	<i>Open GCB</i>	The GCB close relay (relay 3) de-energizes to open the GCB – LED 11 goes out
Delay	<i>Breaker delay</i>	The control unit waits for the breaker transfer time configured in the breaker parameters (page 56) to expire
Operation	<i>Close MCB</i>	The MCB open relay (relay 1) de-energizes to close the MCB – LED 10 illuminates
Delay	<i>Cool down time</i>	The control unit waits for the cool down time configured in the engine parameters (page 55) to expire
Operation	<i>Engine stop</i>	The engine stops – LEDs 12 and 13 go out

Illustration of re-transfer sequence in case of a mains return :

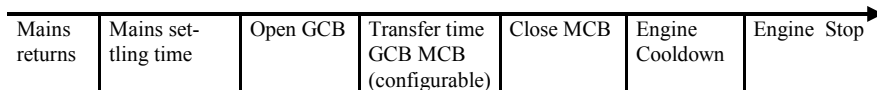

Breaker Closure Limits



Generator Circuit Breaker

The DTSC-50 has fixed breaker closure limits which prevent the GCB closure if the generator voltage and/or frequency is/are not within these limits. These limits depend on the parameters rated system frequency and rated generator voltage (refer to Measuring on page 53) and cannot be changed. The limits are set as follows:

$f_{\text{generator}}$ must be within $f_{\text{rated system}} \pm 10\%$

Examples:

If the rated system frequency is set to 50 Hz, the upper limit is at 55 Hz and the lower limit is at 45 Hz.

If the rated system frequency is set to 60 Hz, the upper limit is at 66 Hz and the lower limit is at 54 Hz.

$V_{\text{generator}}$ must be within $V_{\text{rated generator}} \pm 10\%$

Examples:

If the rated generator voltage is set to 400 V, the upper limit is at 440 V and the lower limit is at 360 V.

If the rated generator voltage is set to 120 V, the upper limit is at 108 V and the lower limit is at 132 V.

If the generator voltage and/or frequency is/are not within these limits, the generator LED  is flashing and the GCB cannot be closed.

If the generator voltage and frequency are within these limits, the generator LED  is permanently on and the GCB may be closed.

Mains Circuit Breaker

The DTSC-50 has flexible breaker closure limits which prevent the MCB closure if the mains voltage and/or frequency is/are not within the mains failure limits.

These limits depend on the parameters rated system frequency and rated mains voltage and can be freely configured (refer to Monitoring: Mains Failure Limits on page 63 for details).

The conditions for closing the MCB are specified as follows and all conditions must be fulfilled:

- The mains voltage is present.
- The mains settling time (refer to Emergency Power (AMF) on page 57) has expired.
- NONE of the following alarms is present:
 - Mains over/underfrequency
 - Mains over/undervoltage
 - Mains rotation field alarm

If the mains voltage is present, but the voltage and/or frequency is/are not within these limits, the mains LED  is flashing, and the MCB cannot be closed.

If the mains voltage and frequency are within these limits, and the mains settling time has expired, the mains LED  is illuminated permanently, and the MCB may be closed.

The mains LED  is off, if the phase-neutral measuring voltage is below 10V.

Functional Description of the 2nd CB Close Delay Time



The DTSC-50 series provides Delayed close GCB and Delayed close MCB signals in the list of configurable parameters (find more details about this under Relay Outputs on page 68) in order to meet the requirements of some special circuit breaker types which require an Enable CB Close signal before the actual CB close signal. The function of these signals is described in the following text.

If those CBs are utilized, they require two Close CB signals with a time delay in between from two different relays. This can be achieved by selecting Delayed close GCB (MCB) from the list of configurable parameters for a freely configurable relay (relay 4 or 5). The delay time can be configured with the parameter 2nd GCB (MCB) Close Delay Time. If the user initiates the command Close GCB (MCB), the signal is immediately issued from the fixed relay (relay2 for GCB or relay 1 for MCB) assigned to give the close command. After the configured delay time has expired, the second Close GCB (MCB) signal is issued. The user configures the delay time for the second close command at the relay output.

Example for the functionality:

Assumption: The close GCB signal is to be issued parallel on a second relay with a delay. Relay 4 shall be used in this example for this. The parameter "Relay 4" has to be configured to "Delayed close GCB" from the list of configurable parameters (refer to Relay Outputs on page 68). The delay time may be configured with the parameter "2nd GCB close delay time"(refer to Application on page 54). A period of 2 seconds shall be configured for this example.

If the user triggers the command "Close GCB" now, the following sequence will be performed:

The signal "Close GCB" energizes the relay firmly assigned to it (relay 3) immediately. After the configured delay has expired, the signal "Close GCB" energizes the relay assigned by the user (relay 4 in this example) with the configured delay.

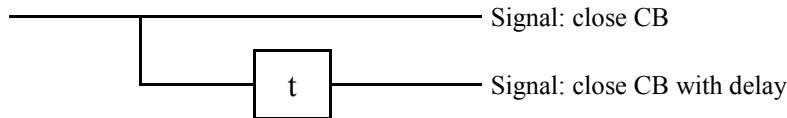

The delay "t" corresponds with the values of the parameters "2nd GCB close delay time" and "2nd MCB close delay time".

If the respective circuit breaker is opened, both relays return to their initial state.



NOTE

This functionality can only be configured using LeoPC1.

Chapter 9. Configuration

Restoring Default Values



The DTSC-50 can be reset to factory settings easily. This may be comfortable for configuring the DTSC-50 from a known state.



NOTE

The unit has to be in **Operating Mode STOP** (page 39) to load the default values.

Resetting Via the Front Panel

Preconditions for loading the default values:

- Unit must be in operation mode STOP – LED 17 is illuminated
- The engine must be stopped – LED 13 is not illuminated
- No generator voltage may be present – LED 12 is not illuminated

Press and hold the UP  7, ALARM  2, and STOP  6 buttons simultaneously for at least 10 seconds to reset the values. The factory default values have been restored when all the LEDs flash briefly,.

Resetting Via LeoPC1

Precondition for loading the default values:

- Unit has to be in operation mode STOP – LED 17 is illuminated

Connect the DTSC-50 with your PC and start LeoPC1 as described in Configuration Using the PC on page 50. Set the parameter Factory settings to YES. Set the parameter Set default values to YES. Now, the default values are loaded.

Configuration Via the Front Panel



Operating the control unit via the front panel is explained in Configuring the on page 29. Familiarize yourself with the unit, the buttons' meaning/function, and the display monitoring using this section. The display of the parameters via the front panel and the display of the parameters via the computer program LeoPC1 will differ.



NOTE

Not all parameters may be accessed or changed when configuring the control unit via the front panel. To properly commission a control unit, LeoPC1 v3.1xxx or higher and a DPC cable (P/N 5417-557) are required.

Configuration Using the PC



CAUTION

For the configuration of the unit via the PC please use the LeoPC1 software with the following software version:

LeoPC1 3.1 or higher



NOTE

Please note that configuration using the direct configuration cable DPC (product number 5417-557) is possible starting with revision B of the DPC (first delivered July 2003). If you have an older model please contact our sales department.

For configuration of the unit via PC program please proceed as follows:

- Install the LeoPC1 program on your notebook/PC according to the provided user manual 37146. Consider the options that are given during the installation.
- Prior to the completion of the installation you will be prompted to select the language with which you want to start the PC program. The language of LeoPC1 may be changed at any time. The selection of the language refers only to language with which the menus and subprograms that LeoPC1 program works with. This setting will not change the configured language of the control unit.
- After the installation of LeoPC1 has been completed it is necessary to reboot your notebook/PC.
- Establish a connection between your notebook/PC and the control unit via the DPC cable. Insert the RJ45 plug into the RJ45 port on the control unit (see DPC – Direct Configuration Cable on page 26 for details) and the serial cable to the COM1 port of your notebook/PC.
- You can now start the PC program as follows:
 - by "Start/Program/Woodward/LeoPC1" (version 3.1 or higher) and opening the respective cfg file, or
 - by a double click on the respective file ending ".cfg" in the subdirectory "/LeoPC1".The cfg files differ in their language used. Use the file on the enclosed floppy disk with the language you want, i.e. US for US English or DE for German.
- After the LeoPC1 program has started, establish communication by pressing the F2 button or selecting Communication -> Connect from the menu. This will establish a data link between the control unit and the notebook/PC.
- Start the configuration routine pressing the F3 button or selecting Devices -> Parameterize from the menu and adjust the parameter of the unit to your application using this manual.



NOTE

You find detailed information about LeoPC1 and the utilization of the software in the user manual 37146 belonging to it.



NOTE

The connection cables delivered with the DPC must be used to connect it to ensure a proper function of the DTSC-50. An extension or utilization of different cable types for the connection between DTSC-50 and DPC may result in a malfunction of the DTSC-50. This may further result in damage to components of the system. If an extension of the data connection line is required, only the serial cable between DPC and notebook/PC may be extended.



NOTE

Unplug the DPC after configuration to ensure a safe operation! If the DPC remains plugged into the DTSC-50 unit, a safe operation of the unit can not be guaranteed.

Editing the Configuration File



If you want to edit the configuration file in order to inhibit resetting the counters, you have to proceed as follows:

Open the configuration file in a text editor

In order to edit the configuration file, open the respective *.asm file in the "Tools" subdirectory of your LeoPC1 installation path with a text editor like Microsoft Notepad. An example of a name (depending on unit and software version) for a configuration file is:

```
8440-1894_NEW_DTSC50_v10000_pDirUS.asm
```

Delete the lines which are used to display the counter entries in the LeoPC1 configuration

The lines to be deleted in the *.asm file are:

```
;!K <b> <color=EE0000> --CONFIG.COUNTERS---</b>
%TAB 0,0,0,H'03;!z2550,"> Maintenance hours","0000h",1.0,0,9999
%TAB 0,0,0,H'03;!M2562,"> reset maintenance period h" ,H'FFFF,2,"No","Yes"
%TAB 0,0,0,H'03;!l2515,"> Counter value preset","00000000",1.0
%TAB 0,0,0,H'03;!M2554,"> Set operation hours" ,H'FFFF,2,"No","Yes"
%TAB 0,0,0,H'03;!z2540,"> Number of starts","00000",1.0,0,65535
```

Store the modified file

Store the modified configuration file back to the "Tools" subdirectory of your LeoPC1 installation path under the same file name.

If you load the modified file in LeoPC1 now, the deleted lines will not be displayed in the configuration menu anymore.

Chapter 10. Parameters

The following description of parameters is expanded to include all parameters that are accessible through LeoPC1. Not all parameters are accessible via the front panel. Most of the parameters, which are accessible via the front panel are password protected and are only accessible after entering a password.

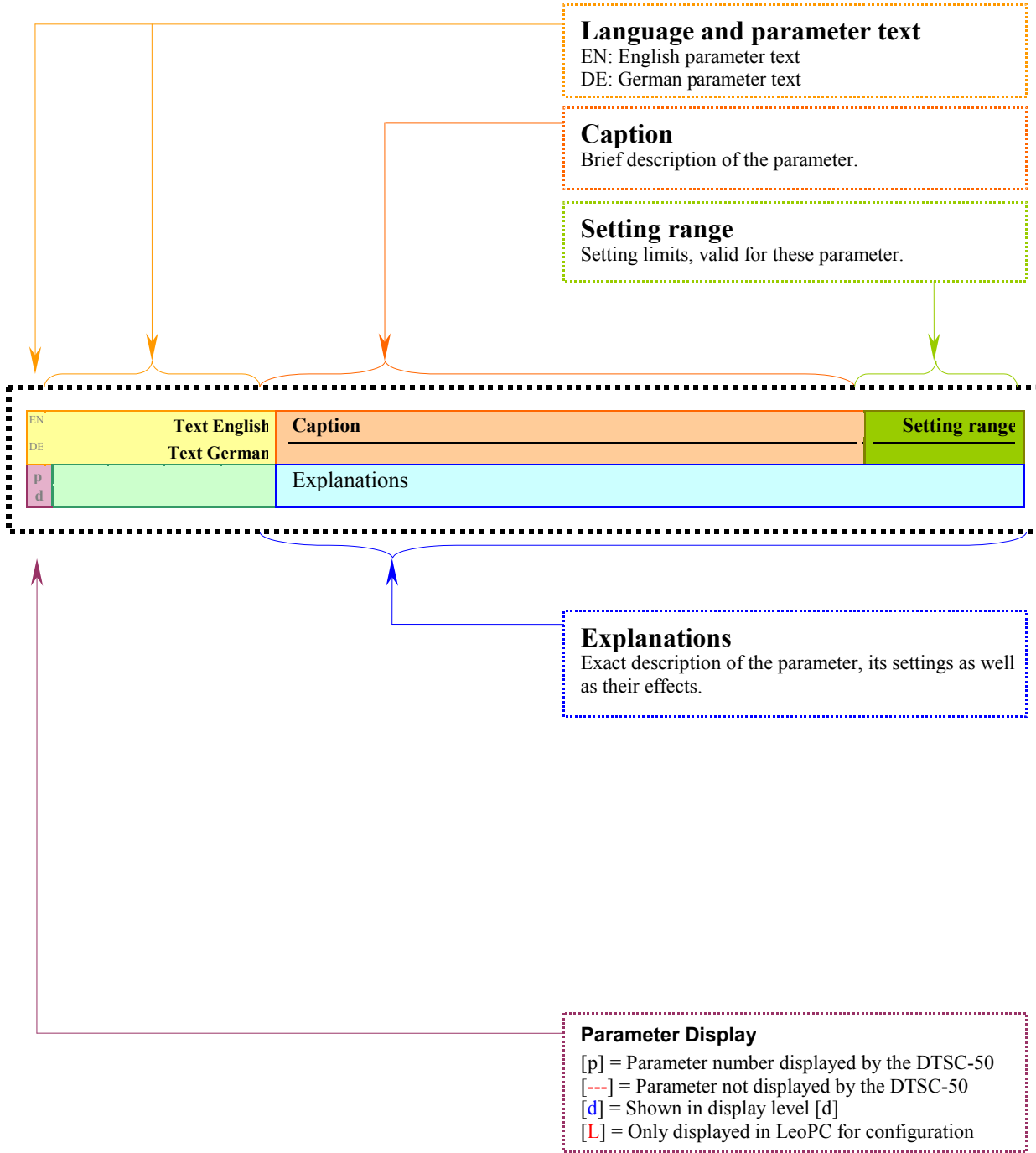

Measuring



EN	<i>Rated system frequency</i>	Rated system frequency	50/60 Hz
DE	<i>Nennfrequenz im System</i>		
10		The rated frequency of the system has to be configured here.	
3		The generator frequency monitoring as well as the mains failure limits refer to the value configured in this parameter.	
EN	<i>Rated voltage generator</i>	Rated generator voltage	50 to 480 V
DE	<i>Nennspannung Generator</i>		
11		The rated voltage of the generator has to be configured here.	
3		The generator voltage monitoring refers to the value configured in this parameter.	
EN	<i>Rated voltage mains</i>	Rated mains voltage	50 to 480 V
DE	<i>Nennspannung Netz</i>		
12		The rated voltage of the mains has to be configured here.	
3		The mains failure limits refer to the value configured in this parameter.	
EN	<i>Generator voltage measuring</i>	Generator voltage measurement	3Ph 4W / 3Ph 3W / 1Ph 2W / 1Ph 3W
DE	<i>Gen. Spannungsmessung</i>		
--		The method of voltage measurement for the generator.	
L		A detailed description of the different measurement methods can be found in Voltage Measuring on page 17.	
EN	<i>Mains voltage measuring</i>	Mains voltage measurement	3Ph 4W / 3Ph 3W / 1Ph 2W / 1Ph 3W
DE	<i>Netz Spannungsmessung</i>		
--		The measurement principle for the mains.	
L		A detailed description of the different measurement methods can be found in Voltage Measuring on page 17.	



NOTE

The correct configuration of these parameters is essential for a proper operation of the control unit.

Application



DE EN <hr/> DE EN <hr/> L	Ignore CB reply Ignoriere Rückmeldung LS	Ignore CB reply YES/NO
		This parameter controls the function of the discrete inputs DI4 and DI5. YES The discrete inputs DI4 and DI5 are freely configurable. The parameters of the discrete inputs can be accessed and configured via LeoPC1. NO The discrete inputs DI4 and DI5 operate as reply inputs for the mains (DI4) or generator (DI5) circuit breaker. The parameters of the discrete inputs can be accessed via LeoPC1 but cannot be changed.



CAUTION

The customer must ensure that a mechanical interlock for the circuit breakers exists for the case that the parameter "Ignore CB reply" is configured to "YES".

DE EN <hr/> DE EN <hr/> L	2nd GCB close Delay time Verz. Zeit zweiten GLS schließen	2nd GCB close delay time 0.00 to 650.00
		This parameter controls the delay for the 2 nd GCB close signal. The application and behavior of this signal is described under Functional Description of the 2nd CB Close Delay Time on page 48.

DE EN <hr/> DE EN <hr/> L	2nd MCB close Delay time Ver. Zeit zweiten NLS schließen	2nd MCB close delay time 0.00 to 650.00
		This parameter controls the delay for the 2 nd MCB close signal. The application and behavior of this signal is described under Functional Description of the 2nd CB Close Delay Time on page 48.

DE EN <hr/> DE EN <hr/> L	Startup in mode Einschalten in Betriebsart	Operating mode after applying the power supply Stop / Auto / Manual / last
		If the controller is powered down, the unit will start in the following configured mode when it is powered up again. Stop The unit starts in the STOP operating mode. Auto The unit starts in the AUTOMATIC operating mode. Manual The unit starts in the MANUAL operating mode. last The unit starts in the last operating mode the control was in prior to being de-energized.

Engine



Engine: Start/Stop Automatic

EN	Cool down time	Cool down time	0 to 999 s
DE	Motor Nachlaufzeit		
40		Regular stop: If the engine performs a normal stop or changed into the STOP operation mode, a cool down with an opened GCB is carried out. This time is adjustable.	
3			
		Stop by an alarm of class F: If a class F alarm is detected, the GCB will open immediately and the engine will shutdown without a cool down.	
EN	Engine monit. delay time	Engine monitoring delay time	0 to 99 s
DE	Motorverzögerung		
--		The engine monitoring is delayed to prevent initiating an alarm while the generator set is starting. The DTSC-50 does not monitor under-voltage and –frequency and low oil pressure alarms until the delay time has expired.	
L			
EN	Engine start fail delay	Engine start fail delay	0 to 999 s
DE	Motorstart Fehlerverzögerung		
--		As soon as the “Engine Start Relay” (Relay 2) is set, the “Engine start fail delay timer” is triggered. If the DTSC-50 does not recognize any generator voltage and frequency, and the “Engine start fail delay timer” has expired then a “Engine start fail” alarm is triggered.	
L			



NOTE

This alarm will NOT cause the “Engine Start Relay” to de-energize. The engine will be kept running.

Breaker



DE EN
GCB frequency window
GLS Frequenzabweichung

Breaker: "Command: GCB close": maximum frequency deviation **0.2 to 10.0 %**

--
L

This is the maximum amount that the frequency will be allowed to deviate from the rated frequency and the "Command: GCB close" may be issued. This is to prevent the prime mover from going into an underfrequency condition due to overloading.

DE EN
GCB voltage window
GLS Spannungsabweichung

Breaker: "Command: GCB close": maximum voltage deviation **1 to 100 %**

--
L

This is the maximum amount that the voltage will be allowed to deviate from the rated voltage and the "Command: GCB close" may be issued.

DE EN
Gen. settling time
GLS Schalterverzögerung

Breaker: "Command: GCB close": Breaker delay **0 to 99 s**

--
L

The time configured here begins to count down once the engine monitoring delay timer has expired. This permits for an additional delay time before the breaker is closed in order to ensure that none of the engine delayed watchdogs trips.

DE EN
Transfer time GCBMCB
Pasuenzeit GLSNLS

Transfer time GCB/MCB **0.10 to 99.99 s**

--
L

Switching from generator supply to mains supply or from mains supply to generator supply occurs automatically depending on the operating conditions. The time between the reply "power circuit breaker is open" and a close-pulse is set by this parameter. This time applies for both directions. During this time the busbar is dead.

Emergency Power (AMF)



EN	On/Off	Emergency power monitoring On/Off	ON/OFF
DE	Ein/Aus		
L		<p>ON.....If the unit is in operating mode AUTOMATIC and a mains fault according to the following parameters occurs, the engine is started and an automatic emergency operation is carried out.</p> <p>OFF.....No emergency operation is carried out.</p>	

EN	Mains fail delay time	Mains fail delay time	0.20 to 99.99 s
DE	Startverzögerung		
L		<p>The minimum period of time that the monitored mains must be dead without interruption for the generator to start and carry out an emergency operation.</p>	

EN	Mains settling time	Mains settling time	0 to 9,999 s
DE	Netzberuhigungszeit		
80		<p>The DTSC-50 will recognize that the mains have returned and are stable after they have been detected within the rated limits without interruption for the time configured in this parameter. If the mains drop below or rise above the configured limits the timer will start over. The load transfer from generator back to mains will be delayed by this parameter after a emergency power operation.</p>	
3			

EN	Bypass mains settling timer on Genset fail	Bypass mains settling timer on Genset fail	YES/NO
DE	Netzberuhigungszeit nicht abwarten bei Generator Ausfall		
L		<p>Often the “Mains settling timer” in applications is configured to for example 30 Minutes to ensure that the mains is really in a good condition before a re-transfer is initiated. It could happen, that the mains returns while the “Mains settling timer” is triggered and the Engine/Genset fails. Usually the full “mains settling time” needs to be awaited until any further actions are triggered. In many ATS applications it is NOT wished to wait the full “Mains settling time” in such a situation, because the Load is not supplied by any source in that case.</p>	

With parameter “Bypass mains settling timer on Genset fail” the behavior of the DTSC-50 can be selected :

1.) “Bypass mains settling timer on Genset fail” configured to “No” :

The full “Mains settling time” needs to expire before a re-transfer to the mains source is initiated.

2.) “Bypass mains settling timer on Genset fail” configured to “Yes” :

The “Mains settling timer” is automatically bypassed if the Genset fails while the “Mains settling timer” is timing.

Password



EN	Password
DE	Passwort

HMI Password

0000 to 9999

00

1

The HMI password must be entered here to configure the control via the front panel. Once the password is entered, access to the configuration menus will be allowed for two hours. A user may exit the configuration mode by allowing the entered password to expire after two hours or by changing any one digit on the random number generated on the password screen and entering it into the unit. The default password is 0003.



NOTE

The HMI password may be set with the parameter "Commissioning level code" (refer to Codes on page 72).

Monitoring



EN	Time until horn reset	Time until horn reset	0 to 1,000 s
DE	Zeit bis Hupenreset		
01		The alarm LED flashes and the centralized alarm (horn) is issued when a new B to F class alarm is detected. After the delay time configured in "Time until horn reset" has expired, the flashing alarm LED changes to steady illumination and the centralized alarm (horn) is reset.	
1		If this parameter is configured to 0 the horn will never be set.	

Monitoring: Generator

EN	Voltage monitoring generator	Voltage monitoring generator	fixed to 4 phase
DE	Spg. Überwachung Generator		
--		The line voltages are monitored for the setting 3Ph 3W. The star voltages are monitored for all other voltage systems.	
--			

Monitoring: Generator Overfrequency

EN	Monitoring	Generator overfrequency monitoring	ON / OFF
DE	Überwachung		
--		ON Overfrequency monitoring is activated	
L		OFF Monitoring is disabled	
		If monitoring is set to "Off", and an overfrequency condition occurs, the engine will be kept running, and the GCB is not opened.	

If monitoring is set to "On", and an overfrequency condition occurs, the engine will be kept running, and the GCB is opened.

EN	Limit	Generator overfrequency limit	50.0 to 130.0 %
DE	Limit		
50		 ⓘ This value refers to the Rated system frequency (see page 53). 	
3		The percentage threshold value that is to be monitored. If this value is reached or exceeded for at least the delay time, the action specified by the configured alarm class is initiated.	

EN	Delay	Generator overfrequency delay	0.1 to 99.9 s
DE	Verzögerung		
51		If the monitored value exceeds the threshold value for the configured delay time, an alarm will be issued. If the monitored value falls below the threshold (minus the hysteresis) before the delay expires, the delay will be reset.	
3			

EN	Alarm class	Generator overfrequency alarm class	fixed to B
DE	Alarmklasse		
--		The generator overfrequency alarm class is set to "B" and cannot be changed.	
L			

EN	Self acknowledge	Generator overfrequency self acknowledgement	ON / OFF
DE	Selbstquittierend		
--		YES The control automatically clears the alarm if it is no longer valid.	
L		NO An automatic reset of the alarm does not occur. The reset occurs manually by pressing the "Acknowledge" button.	

Monitoring: Generator Underfrequency

DE	EN	<i>Monitoring</i>	Generator underfrequency monitoring	ON / OFF
DE		<i>Überwachung</i>		
--			ON Underfrequency monitoring is activated	
L			OFF Monitoring is disabled	
<p>If monitoring is set to “Off”, and an underfrequency condition occurs, the engine will be kept running, and the GCB is not opened.</p> <p>If monitoring is set to “On”, and an underfrequency condition occurs, the engine will be kept running, and the GCB is opened.</p>				
DE	EN	<i>Limit</i>	Generator underfrequency limit	50.0 to 130.0 %
DE		<i>Limit</i>		
52			ⓘ This value refers to the Rated system frequency (see page 53).	
3			The percentage threshold value that is to be monitored. If this value is reached or fallen below for at least the delay time, the action specified by the configured alarm class is initiated.	
DE	EN	<i>Delay</i>	Generator underfrequency delay	0.1 to 99.9 s
DE		<i>Verzögerung</i>		
53			If the monitored value exceeds the threshold value for the configured delay time, an alarm will be issued. If the monitored value falls below the threshold (minus the hysteresis) before the delay expires, the delay will be reset.	
3				
DE	EN	<i>Alarm class</i>	Generator underfrequency alarm class	fixed to B
DE		<i>Alarmklasse</i>		
--			The generator underfrequency alarm class is set to "B" and cannot be changed.	
L				
DE	EN	<i>Self acknowledge</i>	Generator underfrequency self acknowledgement	ON / OFF
DE		<i>Selbstquittierend</i>		
--			YES The control automatically clears the alarm if it is no longer valid.	
L			NO An automatic reset of the alarm does not occur. The reset occurs manually by pressing the “Acknowledge” button.	
DE	EN	<i>Delayed by engine speed</i>	Generator underfrequency delayed by engine speed	fixed to YES
DE		<i>Verzögert durch Motordrehz.</i>		
--			The generator underfrequency delay by engine speed is set to "YES" and cannot be changed. Monitoring is delayed by the time configured in Engine monitoring delay time on page 55 after starting the engine.	
--				

Monitoring: Generator Overvoltage

EN DE --- ---	Monitoring Überwachung	Generator overvoltage monitoring ON / OFF <hr/> ON Overvoltage monitoring is activated. OFF Monitoring is disabled <p>If monitoring is set to “Off”, and an overvoltage condition occurs, the engine will be kept running, and the GCB is not opened.</p> <p>If monitoring is set to “On”, and an overvoltage condition occurs, the engine will be kept running, and the GCB is opened.</p>
EN DE 54 3	Limit Limit	Generator overvoltage limit 50.0 to 125.0 % <hr/> ⓘ This value refers to the Rated generator voltage (see page 53.) <p>The percentage threshold value that is to be monitored. If this value is reached or exceeded for at least the delay time, the action specified by the configured alarm class is initiated.</p>
EN DE 55 3	Delay Verzögerung	Generator overvoltage delay 0.1 to 99.9 s <hr/> If the monitored value exceeds the threshold value for the configured delay time, an alarm will be issued. If the monitored value falls below the threshold (minus the hysteresis) before the delay expires, the delay will be reset.
EN DE --- L	Alarm class Alarmklasse	Generator overvoltage alarm class fixed to B <hr/> The generator overvoltage alarm class is set to "B" and cannot be changed.
EN DE --- L	Self acknowledge Selbstquittierend	Generator overvoltage self acknowledgement ON / OFF <hr/> YES The control automatically clears the alarm if it is no longer valid. NO An automatic reset of the alarm does not occur. The reset occurs manually by pressing the “Acknowledge” button.
EN DE --- ---	Delayed by engine speed Verzögert durch Motordrehz.	Generator overvoltage delayed by engine speed fixed to NO <hr/> The generator overvoltage delay by engine speed is set to "NO" and cannot be changed. The monitoring is not delayed by the time configured in Engine monitoring delay time on page 55 after starting the engine.

Monitoring: Generator Undervoltage

DE EN <hr/> DE EN 56 3	Monitoring Überwachung <hr/> Limit Limit Delay Verzögerung Alarm class Alarmklasse Self acknowledge Selbstquittierend Delayed by engine speed Verzögert durch Motordrehz.	Generator undervoltage monitoring ON / OFF <hr/> ON Undervoltage monitoring is activated. OFF Monitoring is disabled <p>If monitoring is set to “Off”, and an undervoltage condition occurs, the engine will be kept running, and the GCB is not opened.</p> <p>If monitoring is set to “On”, and an undervoltage condition occurs, the engine will be kept running, and the GCB is opened.</p> Generator undervoltage limit 50.0 to 125.0 % <hr/> ⓘ This value refers to the Rated generator voltage (see page 53.) <p>The percentage threshold value that is to be monitored. If this value is reached or fallen below for at least the delay time, the action specified by the configured alarm class is initiated.</p> Generator undervoltage delay 0.1 to 99.9 s <hr/> If the monitored value exceeds the threshold value for the configured delay time, an alarm will be issued. If the monitored value falls below the threshold (minus the hysteresis) before the delay expires, the delay will be reset. Generator undervoltage alarm class fixed to B <hr/> The generator undervoltage alarm class is set to "B" and cannot be changed. Generator undervoltage self acknowledgement ON / OFF <hr/> YES The control automatically clears the alarm if it is no longer valid. NO An automatic reset of the alarm does not occur. The reset occurs manually by pressing the “Acknowledge” button. Generator undervoltage delayed by engine speed fixed to YES <hr/> The generator undervoltage delay by engine speed is set to "YES" and cannot be changed. The monitoring is delayed by the time configured in Engine monitoring delay time on page 55 after starting the engine.
---------------------------------------	--	--

Monitoring: Mains

EN	Monitoring	Mains phase rotation monitoring	fixed to ON
DE	Überwachung		
--			
--			
EN	Mains phase rotation	Mains phase rotation direction	CW / CCW
DE	Netzdrehfeld		
--			
L			
		CW The three-phase measured mains voltage is rotating CW (clock-wise; that means the voltage rotates in direction A-B-C-Phase; default setting).	
		CCW The three-phase measured mains voltage is rotating CCW (counter clock-wise; that means the voltage rotates in direction C-B-A-Phase).	
EN	Delay	Mains phase rotation monitoring delay	fixed to 2 s
DE	Verzögerung		
--			
--			
EN	Alarm class	Mains phase rotation alarm class	fixed to B
DE	Alarmklasse		
--			
--			
EN	Self acknowledge	Mains phase rotation self acknowledgement	YES / NO
DE	Selbstquittierend		
87			
3			
		YES The control will automatically clear the alarm if it is no longer valid.	
		NO An automatic reset of the alarm does not occur. Reset of the alarm must be performed manually by pressing the appropriate buttons.	
EN	Delayed by engine speed	Mains phase rotation delayed by engine speed	fixed to NO
DE	Verzögert durch Motordrehz.		
--			
--			

Monitoring: Mains Failure Limits

EN	High voltage threshold	Emergency power: high voltage threshold	50.0 to 130.0 %
DE	Obere Grenzspannung		
81			
3			
		ⓘ This value refers to the Rated mains voltage (see page 53).	
		This value is referred to for mains failure recognition and mains estimation. If the monitored value exceeds the adjusted limit, this is recognized as a mains failure and an emergency power operation is initiated.	
EN	Low voltage threshold	Emergency power: low voltage threshold	50.0 to 130.0 %
DE	Untere Grenzspannung		
82			
3			
		ⓘ This value refers to the Rated mains voltage (see page 53).	
		This value is referred to for mains failure recognition and mains estimation. If the monitored value exceeds the adjusted limit, this is recognized as a mains failure and an emergency power operation is initiated.	

EN	Voltage hysteresis	Emergency power: voltage hysteresis	0.0 to 50.0 %
DE	Spannungshysterese		
83		<p>ⓘ This value refers to the Rated mains voltage (see page 53).</p>	
3			

This value is referred to for mains failure recognition and mains estimation. If the monitored value exceeds the adjusted limit, this is recognized as a mains failure and an emergency power operation is initiated. If the monitored value has passed a configured limit and returns but remains close to the limit, the hysteresis must be exceeded (on negative deviation monitoring) or fallen below (on exceeding monitoring) for the mains failure to be assessed as over. This must occur uninterrupted for the mains settling time (see parameter on page 57). If the monitored value returns to configured limits, the delay timer is reset to 0. See Figure 10-1.

EN	High frequency threshold	Emergency power: high frequency threshold	70.0 to 160.0 %
DE	Obere Grenzfrequenz		
84		<p>ⓘ This value refers to the Rated system frequency (see page 53).</p>	
3			

This value is referred to for mains failure recognition and mains estimation. If the monitored value exceeds the adjusted limit, this is recognized as a mains failure and an emergency power operation is initiated.

EN	Low frequency threshold	Emergency power: low frequency threshold	70.0 to 160.0 %
DE	Untere Grenzfrequenz		
85		<p>ⓘ This value refers to the Rated system frequency (see page 53).</p>	
3			

This value is referred to for mains failure recognition and mains estimation. If the monitored value exceeds the adjusted limit, this is recognized as a mains failure and an emergency power operation is initiated.

EN	Frequency hysteresis	Emergency power: frequency hysteresis	0.0 to 50.0 %
DE	Frequenzhysterese		
86		<p>ⓘ This value refers to the Rated system frequency (see page 53).</p>	
3			

This value is referred to for mains failure recognition and mains estimation. If the monitored value exceeds the adjusted limit, this is recognized as a mains failure and an emergency power operation is initiated. If the monitored value has passed a configured limit and returns but remains close to the limit, the hysteresis must be exceeded (on negative deviation monitoring) or fallen below (on exceeding monitoring) for the mains failure to be assessed as over. This must occur uninterrupted for the mains settling time (see parameter on page 57). If the monitored value returns to configured limits, the delay timer is reset to 0. See Figure 10-1.

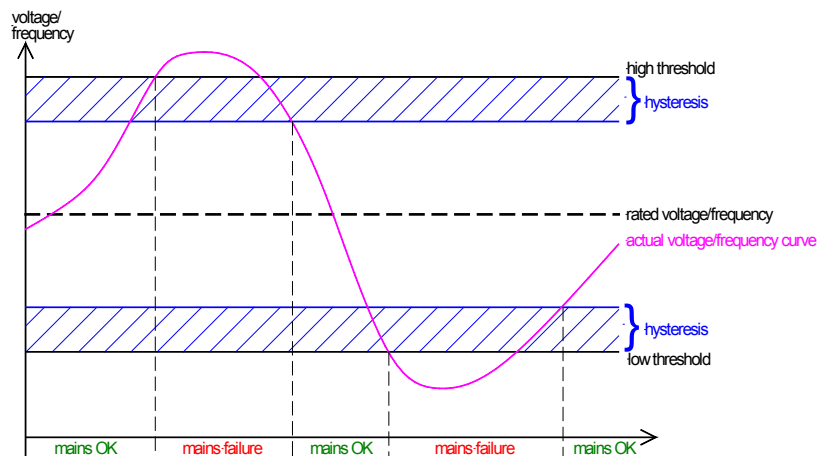

Figure 10-1: Voltage/frequency hysteresis

Monitoring: Engine Start Fail

EN	Monitoring	Engine start fail monitoring	fixed to ON
DE	Überwachung		
--			
--			
EN	Alarm class	Engine start fail alarm class	fixed to B
DE	Alarmklasse		
--			
--			
EN	Self acknowledge	Engine start fail self acknowledgement	fixed to NO
DE	Selbstquittierend		
--			
--			

The engine start fail monitoring is always enabled and cannot be disabled.

The engine start fail alarm class is set to "B" and cannot be changed.

The engine start fail undervoltage self-acknowledgement is set to "NO" and cannot be changed. The alarm will not automatically reset after the fault condition has cleared.

Monitoring: Breakers

EN	GCB monitoring	GCB monitoring	ON / OFF
DE	GLS Überwachung		
--			
L			
EN	GCB monitoring delay	GCB monitoring delay	0.1 to 5.0 s
DE	GLS Überwachungsverzögerung		
--			
L			
EN	MCB monitoring	MCB monitoring	ON / OFF
DE	NLS Überwachung		
--			
L			
EN	MCB monitoring delay	MCB monitoring delay	0.1 to 5.0 s
DE	NLS Überwachungsverzögerung		
--			
L			

If this parameter is set to "ON", "open and close" failures will be detected. If this parameter is set to "OFF", the "open/close" failure detection feature is disabled.

If a transfer command is given, to open or close the GCB, then this timer will be Started. If no GCB reply signal is detected and the GCB monitoring delay time has expired, then one of the following alarms will be triggered :

Alarm Number "51A" = GCB close failure
Alarm Number "52A" = GCB open failure

If this parameter is set to "ON", "open and close" failures will be detected. If this parameter is set to "OFF", the "open/close" failure detection feature is disabled.

If a transfer command is given, to open or close the MCB, then this timer will be Started. If no MCB reply signal is detected and the MCB monitoring delay time has expired, then one of the following alarms will be triggered :

Alarm Number "53A" = MCB close failure
Alarm Number "54A" = MCB open failure

Monitoring: Engine Unintended Stop

EN	<i>Monitoring</i>	Engine unintended stop monitoring	fixed to ON
DE	<i>Überwachung</i>		
The engine unintended stop monitoring is always enabled and cannot be disabled.			
EN	<i>Alarm class</i>	Engine unintended stop alarm class	fixed to B
DE	<i>Alarmklasse</i>		
The engine unintended stop alarm class is set to "B" and cannot be changed.			

Discrete Inputs



The DTSC-50 has 5 discrete inputs (DI1 to DI5). The discrete inputs 1 & 2 are pre-defined as manual mode (DI1) and auto mode (DI2). The discrete input 3 is a control input for remote start. The functions of the discrete inputs 4 and 5 are dependent on the parameter Ignore CB reply (see page 54). If this parameter is set to NO, these discrete inputs are configured as reply inputs for MCB (DI4) and GCB (DI5). Any changes made to the settings of the discrete inputs DI4 and DI5 have no effect. If this parameter is set to YES, these inputs can be configured freely with the following parameters using LeoPC1.

EN DE -- L	DI {x} operation DI {x} Funktion	Discrete Input DI {x} operation N.O. / N.C. <hr/> The discrete input can be operated by a Normally Open contact or a Normally Closed contact. The Normally Closed contact input can be use to monitor for a broken wire. A positive or negative voltage potential can be applied. N.O. The discrete input is analyzed as "present" by energizing a voltage potential (N.O. / operating current). N.C. The discrete input is analyzed as "present" by de-energizing a voltage potential (N.C. / idle current).
EN DE -- L	DI {x} delay DI {x} Verzögerung	Discrete Input DI {x} delay 0.02 to 650.00 s <hr/> A delay time in seconds may be assigned to each alarm input. The fault condition must be continuously present for the delay time at the input before tripping occurs.
EN DE -- L	DI {x} alarm class DI {x} Alarmklasset	Discrete Input DI {x} alarm class A / B / C / D / E / F / Control <hr/> ⓘ see chapter Alarm Classes on page 79. An alarm class can be assigned to a discrete input. The alarm class is initiated when the discrete input receives a triggering signal. Only alarm classes B and F are implemented in the DTSC-50. If "control" has been configured as the alarm class, the discrete input can be evaluated by the relay outputs if configured accordingly (see Relay Outputs on page 68 for more information).
EN DE -- L	DI {x} delayed by eng. speed DI {x} verzög. d. Motordrehz.	Discrete Input DI {x} delayed by engine speed YES / NO <hr/> YES The input monitoring is delayed by the engine. Therefore the conditions of the parameter Engine monitoring delay time on page 55 must be fulfilled. NO The input monitoring is not delayed by the engine. The input is analyzed immediately.
EN DE -- L	DI {x} self acknowledge DI {x} Selbstquittierend	Discrete Input DI {x} self acknowledge YES / NO <hr/> YES The control will automatically clear the alarm if the fault is no longer present. NO An automatic reset of the alarm does not occur. Reset of the alarm must be performed manually by pressing the appropriate buttons, by enabling the appropriate discrete input, or via an interface.

Relay Outputs



The DTSC-50 has 6 relay outputs. The relay outputs 4, 5 and 6 can be freely configured with one signal output from the list of configurable parameters in Table 10-1. If this signal is triggered, the relay will be operated.

EN DE	Relay 1 Relais 1	Relay output 1	fixed to open MCB
---		The relay output is preset to the command open MCB and cannot be changed.	

EN DE	Relay 2 Relais 2	Relay output 2	engine start
---		This relay output is present as “Engine start” contact, and can not be changed.	

EN DE	Relay 3 Relais 3	Relay output 3	close GCB
---		The relay output is preset to the command open GCB and cannot be changed.	

EN DE	Relay 4 Relais 4	Relay output 4	one from configurable parameter list
---		The relay output can be configured to one signal out of the configurable parameter list. The available signals are listed below.	

EN DE	Relay 5 Relais 5	Relay output 5	one from configurable parameter list
---		The relay output can be configured to one signal out of the configurable parameter list. The available signals are listed below.	

EN DE	Relay 6 Relais 6	Relay output 6	one from configurable parameter list
---		The relay output can be configured to one signal out of the configurable parameter list. The available signals are listed below.	

The following output signals may be selected from the list of configurable parameters for the relay outputs 4, 5 and 6.

Configurable Parameter	Description
	The assigned relay will energize if ...
MCB fail to close	... the MCB (Mains Circuit Breaker) could not be closed, and alarm Nr. "53A" has been triggered.
MCB fail to open	... the MCB (Mains Circuit Breaker) could not be opened, and alarm Nr. "54A" has been triggered.
GCB fail to close	... the GCB (Generator Circuit Breaker) could not be closed, and alarm Nr. "51A" has been triggered.
GCB fail to open	... the GCB (Generator Circuit Breaker) could not be closed, and alarm Nr. "52A" has been triggered.
Generator overfrequency 1	... the generator frequency is exceeded (refer to Monitoring: Generator Overfrequency on page 59 for details)
Generator underfrequency 1	... the generator frequency is fallen below (refer to Monitoring: Generator Underfrequency on page 60 for details)
Generator overvoltage 1	... the generator voltage is exceeded (refer to Monitoring: Generator Overvoltage on page 61 for details)
Generator undervoltage 1	... the generator voltage is fallen below (refer to Monitoring: Generator Undervoltage on page 62 for details)
Mains phase rotation mismatch	... the mains phase rotation is wrong (refer to Monitoring: Mains on page 63 for details)
Start fail	... the engine failed to start within 3 attempts (refer to Monitoring: Engine Start Fail on page 65 for details)
Unintended stop	... the engine has stopped unintentionally (refer to Monitoring: Engine Unintended Stop on page 66 for details)
Maintenance hours exceeded	... the maintenance hours are exceeded (refer to Counter on page 70 for details)
Discrete Input DI 1	... discrete input DI 1 is energized
Discrete Input DI 2	... discrete input DI 2 is energized
Discrete Input DI 3	... discrete input DI 3 is energized
Discrete Input DI 4	... discrete input DI 4 is energized
Discrete Input DI 5	... discrete input DI 5 is energized
Automatic operation mode	... the unit is in Automatic operation mode
All alarm classes	... an alarm of any class is issued
Stopping alarm	... an alarm of a class higher than B is issued
Engine released	... as soon as an engine start is initiated
Horn	... an alarm of class B or higher is issued
Delayed close GCB	... a GCB close command has been issued and the configured 2nd GCB close delay time has expired (refer to Application on page 54 for details)
Delayed close MCB	... an MCB close command has been issued and the configured 2nd MCB close delay time has expired (refer to Application on page 54 for details)
Mains failure	... the Mains voltage and/or frequency have exceeded the limits configured by the "Mains failure limits".
Mains OK	... the mains voltage and/or frequency is within the limits configured by the "Mains failure limits".

Table 10-1: Relay outputs - list of configurable parameters

Counter



EN	<i>Maintenance hours</i>	Maintenance hours	0 to 9,999 h
DE	<i>Wartungsintervall Stunden</i>	<p> ⓘ To disable the maintenance counter "hours" configure "0". </p>	
70		<p>This parameter defines the remaining hours until the next maintenance call occurs. Once the configured total time (calculated from days and hours) has been exceeded, a message is displayed.</p> <p>If the parameter "Reset maintenance call" is configured to "YES" (see below) the maintenance counter is reset to the configured value.</p>	
1			
EN	<i>Reset maintenance period h</i>	Reset maintenance period hours	YES / NO
DE	<i>Wartungsstunden rücksetzen</i>	<p>If this parameter is configured to "YES" the maintenance counter 'Hours' is set/reset to the configured value. Once the counter has been set/reset, this parameter automatically changes back to "NO".</p>	
71			
1			
EN	<i>Counter value preset</i>	Counter value preset	0 to 99,999.9
DE	<i>Zähler-Setzwert</i>	<p>The operation hour counter is set to this value (the current value is overwritten). This counter may be used to count the operation hours.</p>	

L			
EN	<i>Set operation hours</i>	Set operation hours	YES / NO
DE	<i>Betriebsstunden setzen</i>	<p>If this parameter is configured to "YES" the operation hour counter is set/reset to the configured value. Once the counter has been set/reset, this parameter automatically changes back to "NO".</p>	

L			
EN	<i>Number of starts</i>	Number of starts	0 to 65,535
DE	<i>Anzahl Starts</i>	<p>The start counter is set to this value (the current value is overwritten). This counter may be used to count the number of starts.</p>	

L			

EN Transfers to generator
 DE Transfers zum Generator

Transfers to generator

0 to 65,535

The transfer counter is set to this value (the current value is overwritten). This counter is used to count how often the GCB (Generator Circuit Breaker) was closed and the Generator has picked up load.

The transfer counter will only count under the following circumstances:

- The engine is commanded to run by the DTSC-50 (either in AUTO or MANUAL mode)
- AND
- Generator Voltage is present and voltage and frequency are OK for a transfer.
- AND
- The GCB is closed by the DTSC-50

The transfer counter will NOT count, if:

- The engine was started externally without a run command initiated by the DTSC-50. And the GCB was closed manually.
- OR
- Generator voltage and frequency are NOT OK for a transfer and the GCB was Closed manually.

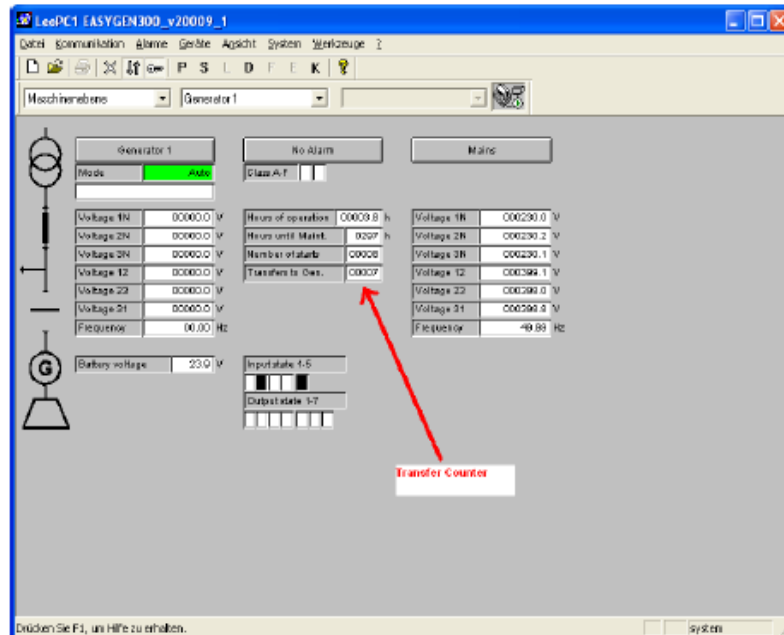

System



Codes

EN	Commissioning level code	Set commissioning level code	0000 to 9999
DE	Code Inbetriebnahme Ebene		
L		The user may configure the HMI password (Parameter 00) here. The HMI password protects the configuration of the unit via the front panel. The new password is valid immediately after changing and confirming it within LeoPC1.	



NOTE

The commissioning level coder (HMI password) will not be reset when restoring the default values.

Factory Settings

EN	Factory settings	Enable to reset to factory settings	ON / OFF
DE	Werkseinstellung		
L		OFF The parameters "Clear event log" and "Set default values" are disabled. ON The parameters "Clear event log" and "Set default values" are enabled. The event log may be cleared and the default values may be restored.	

EN	Clear event log	Clear event log	ON / OFF
DE	Ereignisspeicher löschen		
L		OFF The event log will not be cleared. ON All entries in the event logger will be cleared and this parameter will be reset to "OFF" automatically. The parameter "Factory settings" must be configured "ON" to clear the event log.	

EN	Set default values	Restore default values	ON / OFF
DE	Standardwerte		
L		OFF The default values will not be restored. ON All parameters will be reset to their default values and this parameter will be reset to "OFF" automatically. The parameter "Factory settings" must be configured "ON" to restore the default values.	

Parameter Access Level

EN	Display level	Display level	1 to 3
DE	Anzeigeebene		
72		The user may alter the number of configurable parameters that are displayed on the control unit front panel when the unit is in configuration mode. By selecting the highest level of access (level 3), all parameters will be displayed. The lower the access level selected, the fewer parameters are displayed.	
L			

Versions



NOTE

The following parameters are not configurable. They may be viewed using LeoPC1 for information purposes only.

EN	<i>Serial number</i>	Serial number (S/N)	display only
DE	<i>Seriennummer</i>		
--			
L			
EN	<i>Boot item number</i>	Boot item number (P/N)	display only
DE	<i>Boot Artikelnummer</i>		
--			
L			
EN	<i>Boot revision</i>	Boot revision (REV)	display only
DE	<i>Boot Revision</i>		
--			
L			
EN	<i>Boot version</i>	Boot version	display only
DE	<i>Boot Version</i>		
--			
L			
EN	<i>Program item number</i>	Program item number	display only
DE	<i>Programm Artikelnummer</i>		
--			
L			
EN	<i>Program revision</i>	Program revision	display only
DE	<i>Programm Revision</i>		
--			
L			
EN	<i>Program version</i>	Program version	display only
DE	<i>Programm Version</i>		
--			
L			

Chapter 11. Event Logger



The event logger is a FIFO (First In/First Out) memory for logging alarm events and operation states of the unit. The capacity of the event logger is 15 entries. Additional event messages overwrite the oldest messages. Since the DTSC-50 units do not include a clock module, the operating hours are stored with each event logger entry as the timestamp.

The individual alarm messages, which are stored in the event history, are described in detail under Alarm Messages on page 33. The operation states, which are stored in the event history, are listed in Table 11-1 on page 75.



NOTE

The event logger cannot be read out directly from the front of the unit. It can only be read out using the program GetEventLog, which can either be used as a stand alone or within LeoPC1.

GetEventLog Software



Installing GetEventLog

GetEventLog can either be used as a stand alone or within LeoPC1. In order to call it up from LeoPC1, it must be installed into the LeoPC1 installation path.

To install GetEventLog, start GetEventLog_vxxxxx.exe from the GetEventLog directory on the CD delivered with the unit.

If you want to use GetEventLog from inside LeoPC1, it must be installed into the LeoPC1 installation directory.

Starting GetEventLog

Connect the DTSC-50 to a free COM port on your computer using the DPC as described under Configuration Using the PC on page 50.

Start GetEventLog directly or call it up by selecting GetEventLog from the menu Tools in LeoPC1.

After starting GetEventLog for the first time, you must configure the communication settings. To do this, select the Interface tab, configure the COM port according to the port, to which you have connected the DPC, and enter the other settings as represented in figure Figure 11-1 since these are the default settings of the DTSC-50.

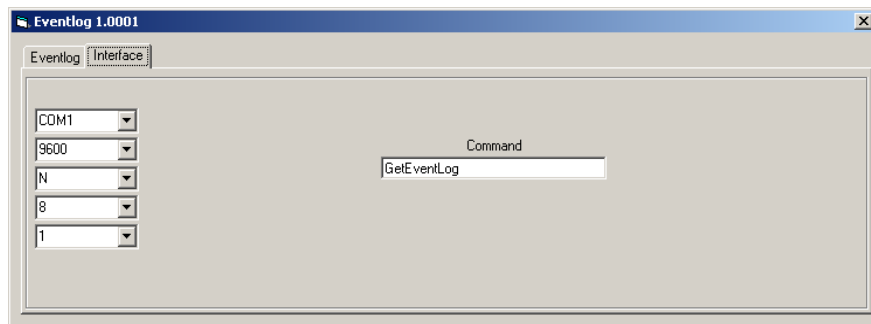

Figure 11-1: GetEventLog - interface configuration

Reading Out GetEventLog

On the Eventlog tab of GetEventLog, click the Request Eventlog button to read out the content of the event logger memory. The content of the event logger is displayed as shown in Figure 11-2.

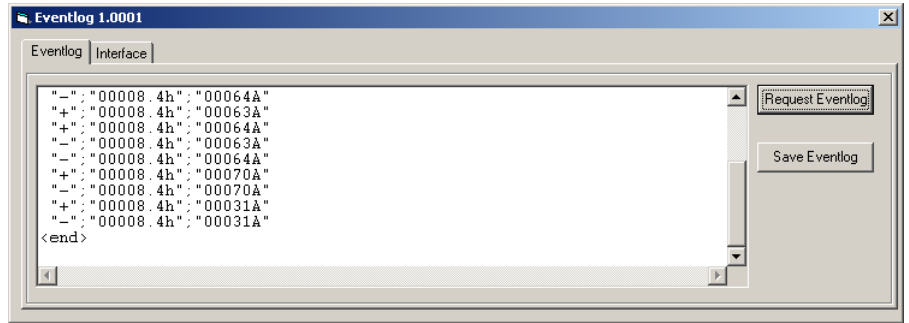

Figure 11-2: GetEventLog - event logger content

The 15 latest events are displayed in chronological order and each entry is composed like this:

"sign";"operating hour";"alarm/state"

whereas **"sign"** "+" indicates the occurrence and "-" indicates the disappearance or acknowledgement of the alarm or state

"operating hour" serves as a timestamp and indicates the operating hour of the event occurred

"alarm/state" indicates the type of alarm or change of state that occurred

The alarm codes are the same as displayed on the unit and described under Alarm Messages on page 33. The codes for the operation states are indicated in Table 11-1 below.

Example: The entry **"+" ; "00008.4h" ; "00031A"** means that alarm 31A unintended stop **"00031A"** occurred **"+"** at operating hour 8.4 **"00008.4h"**. The operating hours are indicated in decimals, i.e. 8.4 hours are 8 hours and 24 minutes.

Number	Operation state	DTSC-50
70	Mode: Automatic	✓
71	Mode: Stop	✓
72	Mode: Manual	✓
73	GCB closed	✓
74	GCB opened	✓
75	MCB closed	✓
76	MCB opened	✓
77	Mains not in range	✓
78	Emergency mode active	✓
79	Engine run	✓

Table 11-1: Event logger - operation states

Storing Event Logger Data

Using the Save Eventlog button on the Eventlog tab, you are able to save the content of the event logger in CSV format (comma separated values).

Resetting the Event Logger

The event logger can only be reset using LeoPC1. To do this, perform the following steps:

Connect the DTSC-50 with your PC and start LeoPC1 as described in Configuration Using the PC on page 50.

Set the parameter Factory settings to YES.

Set the parameter Clear Even Log to YES.

The event logger should be cleared.

Chapter 12. Technical Data

Name plate -----

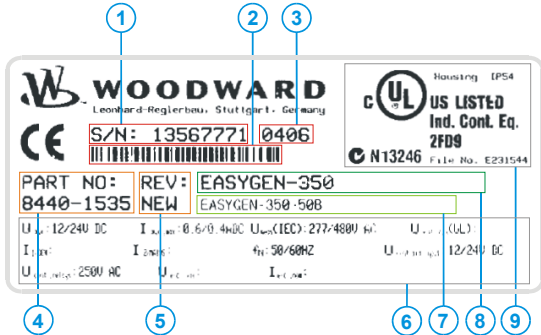

- 1 S/N Serial number (numerical)
- 2 S/N Serial number (Barcode)
- 3 S/N Date of production (YYMM)
- 4 P/N Item number
- 5 REV Item revision number
- 6 Details Technical data
- 7 Type Unit name
- 8 Type Extended description
- 9 UL UL sign

(Example for a typical name plate)

Measuring values -----

Measuring voltages

480 Vac	
Rated value (Vn).....	277/480 Vac
Maximum value (Vmax).....	max. 346/600 Vac
Rated voltage phase – ground.....	300 Vac
Rated surge voltage.....	4.0 kV

- Linear measuring range 1.3 × Vn
- Measuring frequency Generator 15.0 to 85.0 Hz
 Mains 40.0 to 85.0 Hz
- Accuracy Class 1
- Input resistance per path..... 2.0 MΩ
- Maximum power consumption per path < 0.15 W

Ambient variables -----

- Power supply 12/24 Vdc (6.5 to 32.0 Vdc)
 Battery ground (terminal 1) must be grounded to the chassis
- Intrinsic consumption max. 10 W
- Degree of pollution 2
- Ambient temperature Storage -20 to +85 °C / -4 to +185 °F
 Operation -20 to +70 °C / -4 to +158 °F
- Ambient humidity..... 95 %, non condensing

Discrete inputs -----

- Input range (V_{Cont, digital input}) Rated voltage 12/24 Vdc (6.5 to 32.0 Vdc)
- Input resistance..... approx. 6.7 kΩ

Relay outputs -----

- Contact material AgCdO
- General purpose (GP) (V_{Cont, relay output})

AC.....	2.00 Aac@250 Vac
DC.....	2.00 Adc@24 Vdc
	0.36 Adc@125 Vdc
	0.18 Adc@250 Vdc
- Pilot duty (PD) (V_{Cont, relay output})

AC.....	B300
DC.....	1.00 Adc@24 Vdc
	0.22 Adc@125 Vdc
	0.10 Adc@250 Vdc

- Interface** -----
- Service interface**..... **non isolated**
 - Version RS-232
 - Signal level5V
- Level conversion and insulation by using DPC (P/N 5417-557)

- Housing** -----
- Type.....Woodward easYpack 158x158
 - Dimensions (W × H × D)..... 158 × 158 × 40 mm
 - Front cutout (W × H)..... 138 [+1.0] × 138 [+1.0] mm
 - Connection..... screw and plug terminals 2.5 mm²
 - Recommended tightening torque
 - Connectors.....0.5 Nm
 - Housing clamps0.1 Nm
 - use only 60/75 °C copper leads
 - use only class 1 cables (or similar)
 - Weightapprox. 450 g

- Vibration** -----
- Sinusoidal 4 G, 5 Hz to 100 Hz
 - Endurance 4 G, 30 Hz, 1.5 h
 - Random.....1.04 Grms, 10 Hz to 500 Hz, 2 h

- Shock** -----
- Shock40 G peak, 11 ms

- Protection**-----
- Protection system..... IP54 from front for proper installation with gasket pending
 - Front folio.....insulating surface
 - EMC test (CE) tested according to applicable EN guidelines
 - Listings CE marking; UL listing for ordinary locations
 - Type approval..... UL/cUL, Ordinary Locations, File No.: 231544

- Standards**-----
- ShockEN 60255-21-2
 - Vibration..... EN 60255-21-1; EN 60255-21-3
 - Temperature..... IEC 60068-2-30; IEC 60068-2-2; IEC 60068-2-1

Chapter 13.

Accuracy

Measuring value		Display	Accuracy	Notes
Frequency				
Generator	$f_{L1N}, f_{L2N}, f_{L3N}$	15.0 to 85.0 Hz	0.1 %	-
Mains	$f_{L1N}, f_{L2N}, f_{L3N}$	40.0 to 85.0 Hz	0.1 %	-
Voltage				
Generator	$V_{L1N}, V_{L2N}, V_{L3N},$	0 to 600 V	1 %	Transformer ratio selectable
Mains	$V_{L1N}, V_{L2N}, V_{L3N},$	0 to 600 V	1 %	Transformer ratio selectable
Miscellaneous				
Operating hours		0 to 99,999.9 h		-
Maintenance call		0 to 9,999 h		-
Start counter		0 to 65,535		-
Battery voltage		6.5 to 32 V	1 %	-

Reference conditions (to measure the accuracy):

- Input voltage sinusoidal rated voltage
- Frequency rated frequency $\pm 2\%$
- Power supply rated voltage $\pm 2\%$
- Ambient temperature $23\text{ }^{\circ}\text{C} \pm 2\text{ K}$
- Warm-up period 20 minutes

Appendix A. Common

Alarm Classes



The DTSC-50 provides only the alarm classes B & F:

Alarm class	Visible in the display	LED "Alarm" & horn	Relay "Close GCB" is de-energized	Shut-down engine	Engine blocked until ack. sequence has been passed
B	yes	yes	no	---	---
	Warning Alarm This alarm does not interrupt the operation. An output of the centralized alarm occurs: ⇒ Alarm text + flashing LED "Alarm" + Relay centralized alarm (horn).				
F	yes	yes	yes	immediately	yes
	Responding Alarm With this alarm the GCB is opened immediately and the engine is stopped. ⇒ Alarm text + flashing LED "Alarm" + Relay centralized alarm (horn)+ GCB open + Engine stop.				

The alarm classes A, C, D, & E can be configured, but are intended for future software revisions **and should not be used**. The behavior of the unit is the following if configured for these alarm classes:

Alarm class	Visible in the display	LED "Alarm" & horn	Relay "Close GCB" is de-energized	Shut-down engine	Engine blocked until ack. sequence has been passed
A	yes	no	no	no	no
	Warning Alarm This alarm does not interrupt the unit operation. A message output without a centralized alarm occurs at the unit: ⇒ Alarm text.				
C	yes	yes	yes	after cool down	yes
	Responding Alarm With this alarm the GCB is opened and the engine is stopped. Coasting occurs. ⇒ Alarm text + flashing LED "Alarm" + Relay centralized alarm (horn) + Coasting + GCB open + Engine stop.				
D	yes	yes	yes	after cool down	yes
	Responding Alarm With this alarm the GCB is opened and the engine is stopped. Coasting occurs. ⇒ Alarm text + flashing LED "Alarm" + Relay centralized alarm (horn) + Coasting + GCB open + Engine stop.				
E	yes	yes	yes	immediately	yes
	Responding Alarm With this alarm the GCB is opened immediately and the engine is stopped. ⇒ Alarm text + flashing LED "Alarm" + Relay centralized alarm (horn)+ GCB open + Engine stop.				



NOTE

If the control unit is in **MANUAL** operation mode, a cool down phase is not performed regardless of the alarm class!

Conversion Factors and Charts



Conversion Factors: Temperature

$^{\circ}\text{C} \Rightarrow ^{\circ}\text{F}$	$^{\circ}\text{F} \Rightarrow ^{\circ}\text{C}$
$1\ ^{\circ}\text{F} = ([\text{Value } ^{\circ}\text{C} \times 1.8\ ^{\circ}\text{F}/^{\circ}\text{C}] + 32\ ^{\circ}\text{F})$	$1\ ^{\circ}\text{C} = \frac{([\text{Value}]\ ^{\circ}\text{F} - 32\ ^{\circ}\text{F})}{1.8\ ^{\circ}\text{F}/^{\circ}\text{C}}$

Table 13-1: Conversion factor: temperature

Conversion Factors: Pressure

$\text{bar} \Rightarrow \text{psi}$	$\text{psi} \Rightarrow \text{bar}$
$1\ \text{psi} = [\text{Value}] \text{ bar} \times 14.501$	$1\ \text{bar} = \frac{[\text{Value}] \text{ psi}}{14.501}$

Table 13-2: Conversion factor: pressure

Conversion Chart: Wire Size

AWG	mm ²	AWG	mm ²	AWG	mm ²	AWG	mm ²	AWG	mm ²	AWG	mm ²
30	0.05	21	0.38	14	2.5	4	25	3/0	95	600MCM	300
28	0.08	20	0.5	12	4	2	35	4/0	120	750MCM	400
26	0.14	18	0.75	10	6	1	50	300MCM	150	1000MCM	500
24	0.25	17	1.0	8	10	1/0	55	350MCM	185		
22	0.34	16	1.5	6	16	2/0	70	500MCM	240		

Table 13-3: Conversion chart: wire size

Appendix B. Front Customization

The DTSC-50 is designed language-independent, but can be customized to your demands using a paper strip. The paper strip is intended for customization and may contain more detailed information about the display.

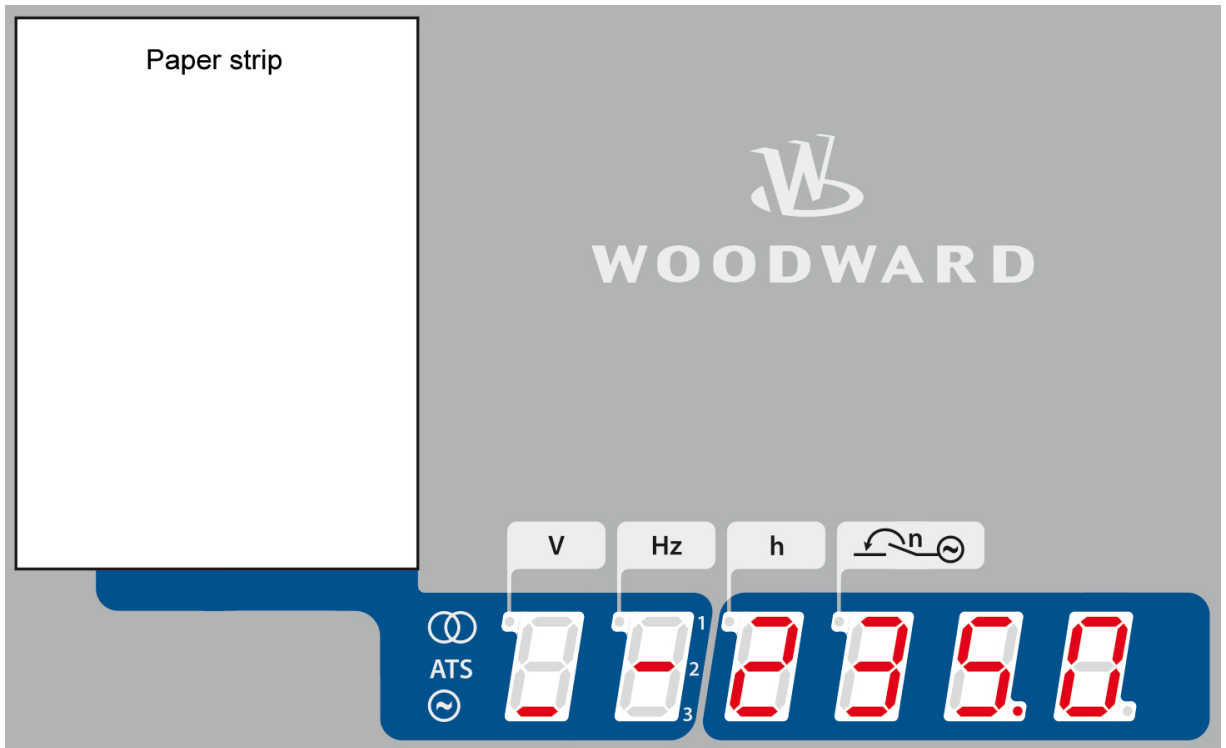

Figure 13-4: Paper strip

The unit is delivered with a English paper strip which contains the alarm messages.

A template for the paper strip can be found in the "Paper Strips" directory on the CD delivered with the unit. The template is in Microsoft Word format and can be customized to your demands. Please note that the paper strip geometry must not be modified in the templates. Just edit the text in the paper strips, print them out, cut out the paper strips where indicated, and insert them into the openings at the side of the unit.

Appendix C. Troubleshooting

If problems are encountered while commissioning or operating the DTSC-50, please refer to the troubleshooting table below and LeoPC1 prior to contacting Woodward for technical assistance. The most common problems and their solutions are described in the troubleshooting table. If problems are encountered between the DTSC-50 and its wiring and the engine or other devices, refer to the respective manuals for solving the problem.

Symptom	Possible cause	Possible solution	Verify
Unit does not power up.	Power supply outside operating range.	With power supply voltage connected to terminals 1(-) and 2(+) of the DTSC-50, measure the voltage at these terminals.	Voltage must be no less than 6.5 Volts and no greater than 32 Volts.
	Power supply polarity reversed.	With power supply voltage connected to terminals 1(-) and 2(+) of the DTSC-50, measure the voltage at these terminals.	Voltage measurement reads (+) polarity when meter is connected to terminal 1(-), and 2(+).
Engine does not start by pressing the "Start" button.	Unit is in operating mode "Stop" and the "Stop" LED is lit.	Unit must be in operating mode "Manual".	Press the "Operating Mode" button twice for selecting manual mode.
	Unit is in operating mode "AUTO".	Unit must be in operating mode "Manual".	Press the "Operating Mode" button twice for selecting manual mode. If the operation mode does not change, please check whether AUTO mode is selected via discrete input 2. No voltage may be applied to discrete input terminal 17, if the user wants to start the engine via the "Start" button on the faceplate.
Engine does not start by setting the "Remote-Start" signal (discrete input 3).	Unit is in operating mode "Stop".	Unit must be in operating mode "Auto" to be started via "Remote-Start" signal.	Press the "Operating Mode" button for selecting "Auto" mode.
	Unit is in operating mode "Manual".	Unit must be in operating mode "Auto" to be started via "Remote-Start" signal.	Press the "Operating Mode" button for selecting "Auto" mode. Operating mode "Manual" may not be set via discrete input terminal 16.
	"Remote-Start" signal is miswired to the DTSC-50.	Measure the voltage between terminals 18/15.	If you set the "Remote Start" signal, you should measure a voltage between terminals 18/15. If a voltage is present at these terminals, everything is wired correctly.

Symptom	Possible cause	Possible solution	Verify
"Generator Circuit Breaker Closed" LED is not lit, although the Circuit Breaker is closed.	"Generator Circuit Breaker Closed" signal is miswired.	Measure the voltage between terminals 20 and 15 on the DTSC-50.	If the circuit breaker is closed, you should measure around 0 Volts between terminals 20 and 15. If around 0 Volts are measured, the "Generator Circuit Breaker Closed" LED should be lit. If the circuit breaker is open, you should measure a voltage similar to the battery voltage in your system between terminals 20 and 15. In this case the "Generator Circuit Breaker Closed" LED must not be lit. Check whether you are using an N.C. contact as breaker aux. contact.
	Wrong setting of Parameter "Ignore Breaker Replies".	Use the Woodward "LeoPC1" configuration software to check for correct setting of the Parameter "Ignore Breaker Replies".	Within the LeoPC1 configuration software, the parameter "Ignore Breaker Replies" must be set to "No" to enable the MCB reply state to be visualized on the "Generator Circuit Breaker Closed" LED. If the parameter "Ignore Breaker Replies" is set to "Yes", the state of the CB reply will not be recognized!
"Mains Circuit Breaker Closed" LED is not lit, although the Circuit Breaker is closed.	"Mains Circuit Breaker Closed" signal is miswired.	Measure the voltage between terminals 19 and 15 on the DTSC-50.	If the circuit breaker is closed, you should measure around 0 Volts between terminals 19 and 15. If around 0 Volts are measured, the "Mains Circuit Breaker Closed" LED should be lit. If the circuit breaker is open, you should measure a voltage similar to the battery voltage in your system between terminals 19 and 15. In this case the "Mains Circuit Breaker Closed" LED must not be lit. Check whether you are using an N.C. contact as breaker aux. contact.
	Wrong setting of Parameter "Ignore Breaker Replies".	Use the Woodward "LeoPC1" configuration software to check for correct setting of the Parameter "Ignore Breaker Replies".	Within the LeoPC1 configuration software, the parameter "Ignore Breaker Replies" must be set to "No" to enable the MCB reply state to be visualized on the "Mains Circuit Breaker Closed" LED. If the parameter "Ignore Breaker Replies" is set to "Yes", the state of the CB reply will not be recognized!

Symptom	Possible cause	Possible solution	Verify
Alarm "30A - Start fail" occurs.	Low fuel situation.	Check, if enough Fuel is present to run the engine.	Fuel level is above fuel pick-up and fuel system is properly primed
	Fuel line connection to the engine is not present.	Check whether the fuel line to engine is installed properly.	No leaks in fuel system and system is primed
	Generator produces no voltage.	Check, if the generator is excited properly.	While the crank is engaged the generator shall produce voltage.
	Engine start relay output of the DTSC-50 is defective or miswired.	Measure the resistance between terminals 8 and 9 on the DTSC-50.	If engine is not started, the resistance between terminals 8 and 9 must be around infinite Ohms. If the DTSC-50 performs an start, the resistance between terminals 8 and 9 must be around 0 Ohms.
Engine does not start	Starting relay output of the DTSC-50 is defective or miswired.	Measure the resistance between terminals 8 and 9 on the DTSC-50.	If engine is not running, the resistance between terminals 8 and 9 should read infinite Ohms. If the DTSC-50 performs a start, the resistance between terminals 8 and 9 must be around 0 Ohms.
Alarm "13A - Generator undervoltage" occurs, after the engine has fired.	Generator voltages are not properly connected to the DTSC-50.	Check generator voltages if engine is started up.	Measure the generator voltages on the terminals 29 / 31 / 33 / 35 while the engine is running. (Please refer to the wiring diagram for your DTSC-50 derivate, because the terminal assignment is different from derivate to derivate.)
	Wrong wiring selected for the generator voltage measurement.	Use the LeoPC1 configuration software to check for settings of parameter "Generator voltage measuring"	Check, which wiring you have to use, and then set the parameter "Generator voltage measuring" via LeoPC1 to one of the following selections : - 1Ph2W - 1Ph3W - 3Ph3W - 3Ph4W See "Chapter 6 - Connections - Voltage measurement Generator" for further details.
	Voltage regulator is not set correctly	Adjust voltage regulator rated voltage or remote voltage setting.	
Alarm 12 "Overvoltage" occurs on startup.	Voltage regulator is not set correctly	Adjust voltage regulator settings for proper response.	Refer to your AVR manual.

Appendix D. List of Parameters

Unit number P/N _____ Rev _____
 Version DTSC- _____
 Project _____
 Serial number S/N _____ Date _____

	Parameter	Setting range	Default value	Customer setting
PASSWORD				
	HMI Password	0000 to 9999	random	
MEASURING				
	Rated system frequency	50/60 Hz	50 Hz	
	Rated voltage generator	50 to 480 V	400 V	
	Rated voltage mains	50 to 480 V	400 V	
	Generator voltage measuring	3Ph 4W 3Ph 3W 1Ph 2W 1Ph 3W	3Ph 4W	<input type="checkbox"/> 3Ph 4W <input type="checkbox"/> 3Ph 4W <input type="checkbox"/> 3Ph 3W <input type="checkbox"/> 3Ph 3W <input type="checkbox"/> 1Ph 2W <input type="checkbox"/> 1Ph 2W <input type="checkbox"/> 1Ph 3W <input type="checkbox"/> 1Ph 3W
	Generator voltage measuring	1Ph 2W	1Ph 2W	n/a n/a
	Mains voltage measuring	3Ph 4W 3Ph 3W 1Ph 2W 1Ph 3W	3Ph 4W	<input type="checkbox"/> 3Ph 4W <input type="checkbox"/> 3Ph 4W <input type="checkbox"/> 3Ph 3W <input type="checkbox"/> 3Ph 3W <input type="checkbox"/> 1Ph 2W <input type="checkbox"/> 1Ph 2W <input type="checkbox"/> 1Ph 3W <input type="checkbox"/> 1Ph 3W
	Mains voltage measuring	3Ph 4W	3Ph 4W	n/a n/a
APPLICATION				
	Ignore CB reply	YES/NO	NO	<input type="checkbox"/> Y <input type="checkbox"/> N <input type="checkbox"/> Y <input type="checkbox"/> N
	2nd GCB Close Delay Time	0.00 to 650.00 s	0.20 s	
	2nd MCB Close Delay Time	0.00 to 650.00 s	0.20 s	
ENGINE				
	Start/stop automatic			
	Cool down time	0 to 999 s	30 s	
	Engine Monit. delay time	0 to 99 s	8 s	
	Engine start fail delay	0 to 999 s	60 s	
BREAKER				
	GCB frequency window	0.2 to 10.0 %	2.0 %	
	GCB voltage window	1 to 100 %	10 %	
	GCB settling time	0 to 99 s	2 s	
	Transfer time GCBMCB	0.10 to 99.99 s	0.10 s	
EMERGENCY POWER (AMF)				
	On/Off	ON/OFF	ON	<input type="checkbox"/> 1 <input type="checkbox"/> 0 <input type="checkbox"/> 1 <input type="checkbox"/> 0
	Mains fail delay time	0.20 to 99.99 s	3.00 s	
	Mains settling time	0 to 9,999 s	20 s	
	Bypass mains settling timer on Genset fail	YES/NO	NO	

Parameter	Setting range	Default value	Customer setting	
MONITORING				
Time until horn reset	0 to 1,000 s	180 s		
Generator protection				
Voltage monitoring generator	4 phase	4 phase	n/a	n/a
Generator: Over frequency				
Monitoring	ON	OFF	n/a	n/a
Limit	50.0 to 130.0 %	110.0 %		
Delay	0.1 to 99.9 s	1.0 s		
Alarm class	B	B	n/a	n/a
Self acknowledge	NO	NO	n/a	n/a
Generator: Under frequency				
Monitoring	ON	OFF	n/a	n/a
Limit	50.0 to 130.0 %	90.0 %		
Delay	0.1 to 99.9 s	5.0 s		
Alarm class	B	B	n/a	n/a
Self acknowledge	NO	NO	n/a	n/a
Delayed by engine speed	YES	YES	n/a	n/a
Generator: Over voltage				
Monitoring	ON	OFF	n/a	n/a
Limit	50.0 to 125.0 %	110.0 %		
Delay	0.1 to 99.9 s	2.0 s		
Alarm class	B	B	n/a	n/a
Self acknowledge	NO	NO	n/a	n/a
Delayed by engine speed	NO	NO	n/a	n/a
Generator: Under voltage				
Monitoring	ON	OFF	n/a	n/a
Limit	50.0 to 125.0 %	92.0 %		
Delay	0.1 to 99.9 s	5.0 s		
Alarm class	B	B	n/a	n/a
Self acknowledge	NO	NO	n/a	n/a
Delayed by engine speed	YES	YES	n/a	n/a
Mains protection				
Monitoring	ON	ON	n/a	n/a
Mains phase rotation	CW (+)/CCW (-)	CW	<input type="checkbox"/> + <input type="checkbox"/> -	<input type="checkbox"/> + <input type="checkbox"/> -
Delay	2 s	2 s	n/a	n/a
Alarm class	B	B	n/a	n/a
Self acknowledge	YES / NO	NO	<input type="checkbox"/> Y <input type="checkbox"/> N	<input type="checkbox"/> Y <input type="checkbox"/> N
Delayed by engine speed	NO	NO	n/a	n/a
Emergency power: Limits				
High voltage threshold	50.0 to 130.0 %	130.0 %		
Low voltage threshold	50.0 to 130.0 %	90.0 %		
Voltage hysteresis	0.0 to 50.0 %	2.0 %		
High frequency threshold	70.0 to 160.0 %	110.0 %		
Low frequency threshold	70.0 to 160.0 %	90.0 %		
Frequency hysteresis	0.0 to 50.0 %	2.0 %		
GCB monitoring	ON / OFF	ON		
GCB monitoring delay	0.1 to 5.0 s	2.0 s		
MCB monitoring	ON / OFF	ON		
MCB monitoring delay	0.1 to 5.0 s	2.0 s		

Parameter	Setting range	Default value	Customer setting	
-----------	---------------	---------------	------------------	--

MONITORING

Engine: Start fail				
Monitoring	ON	ON	n/a	n/a
Alarm class	B	B	n/a	n/a
Self acknowledge	NO	NO	n/a	n/a
Engine: Unintended stop				
Monitoring	ON	OFF	n/a	n/a
Alarm class	B	B	n/a	n/a

DISCRETE INPUTS

Discrete input [DI1] manual mode				
DI 1 operation	N.O.	N.O.	n/a	n/a
DI 1 delay	0.1 s	0.1 s	n/a	n/a
DI 1 alarm class	Control	Control	n/a	n/a
DI 1 delayed by eng. speed	NO	NO	n/a	n/a
DI 1 self acknowledge	NO	NO	n/a	n/a
Discrete input [DI2] auto mode				
DI 2 operation	N.O.	N.O.	n/a	n/a
DI 2 delay	0.1 s	0.1 s	n/a	n/a
DI 2 alarm class	Control	Control	n/a	n/a
DI 2 delayed by eng. speed	NO	NO	n/a	n/a
DI 2 self acknowledge	NO	NO	n/a	n/a
Discrete input [DI3] remote start				
DI 3 operation	N.O.	N.O.	n/a	n/a
DI 3 delay	0.02 s	0.02 s	n/a	n/a
DI 3 alarm class	Control	Control	n/a	n/a
DI 3 delayed by eng. speed	NO	NO	n/a	n/a
DI 3 self acknowledge	NO	NO	n/a	n/a
Discrete input [DI4] reply MCB or freely configurable If parameter "Ignore CB reply" is set to "YES", this input is freely configurable				
DI 4 operation	N.O. / N.C.	N.C.	<input type="checkbox"/> N.O. <input type="checkbox"/> N.C.	<input type="checkbox"/> N.O. <input type="checkbox"/> N.C.
DI 4 delay	0.02 to 650.00 s	0.00 s		
DI 4 alarm class	A/B/C/D/E/F/Control	Control		
DI 4 delayed by eng. speed	YES/NO	NO	<input type="checkbox"/> Y <input type="checkbox"/> N	<input type="checkbox"/> Y <input type="checkbox"/> N
DI 4 self acknowledge	YES/NO	YES	<input type="checkbox"/> Y <input type="checkbox"/> N	<input type="checkbox"/> Y <input type="checkbox"/> N
Discrete input [DI5] reply GCB or freely configurable If parameter "Ignore CB reply" is set to "YES", this input is freely configurable				
DI 5 operation	N.O. / N.C.	N.C.	<input type="checkbox"/> N.O. <input type="checkbox"/> N.C.	<input type="checkbox"/> N.O. <input type="checkbox"/> N.C.
DI 5 delay	0.02 to 650.00 s	0.00 s		
DI 5 alarm class	A/B/C/D/E/F/Control	Control		
DI 5 delayed by eng. speed	YES/NO	NO	<input type="checkbox"/> Y <input type="checkbox"/> N	<input type="checkbox"/> Y <input type="checkbox"/> N
DI 5 self acknowledge	YES/NO	YES	<input type="checkbox"/> Y <input type="checkbox"/> N	<input type="checkbox"/> Y <input type="checkbox"/> N

DIGITAL OUTPUTS

Relay 1	Command: open MCB	open MCB	n/a	n/a
Relay 2	Command: engine start	engine start	n/a	n/a
Relay 3	Command: close GCB	close GCB	n/a	n/a
Relay 4	Free configurable			
Relay 5	Free configurable			
Relay 6	Free configurable			
Relay 7	internal relay			

COUNTER

Maintenance hours	0 to 9,999 h	300 h		
Reset maintenance period h	YES/NO	NO	<input type="checkbox"/> Y <input type="checkbox"/> N	<input type="checkbox"/> Y <input type="checkbox"/> N
Counter value preset	0 to 99,999.9 h	-		
Set operation hours	YES/NO	NO	<input type="checkbox"/> Y <input type="checkbox"/> N	<input type="checkbox"/> Y <input type="checkbox"/> N
Number of starts	0 to 65,535	-		
Transfer to Gen.	0 to 65,535	-		

	Parameter	Setting range	Default value	Customer setting	
SYSTEM					
Codes					
	Comissioning level code	0000 to 9999	0003		
	Factory settings	ON / OFF	OFF	<input type="checkbox"/> 1 <input type="checkbox"/> 0	<input type="checkbox"/> 1 <input type="checkbox"/> 0
	Clear event log	ON / OFF	OFF	<input type="checkbox"/> 1 <input type="checkbox"/> 0	<input type="checkbox"/> 1 <input type="checkbox"/> 0
	Set default values	ON / OFF	OFF	<input type="checkbox"/> 1 <input type="checkbox"/> 0	<input type="checkbox"/> 1 <input type="checkbox"/> 0
	Display level	1 to 3	1		
Versions					
	Serial number	Info	---		
	Boot item number	Info	---		
	Boot revision	Info	---		
	Boot version	Info	---		
	Program item number	Info	---		
	Program revision	Info	---		
	Program version	Info	---		

The output signals, which may be selected from the list of configurable parameters for the discrete outputs 3 and 4, are listed in Table 10-1 on page 69.



NOTE

All parameters shaded in gray color are fixed parameters and cannot be configured by the operator. The "light gray" parameters for DI4 and DI 5 can be configured if the parameter "Ignore CB reply" is set to "YES".

Appendix E. Service Options

Product Service Options



The following factory options are available for servicing Woodward equipment, based on the standard Woodward Product and Service Warranty (5-01-1205) that is in effect at the time the product is purchased from Woodward or the service is performed. If you are experiencing problems with installation or unsatisfactory performance of an installed system, the following options are available:

- Consult the troubleshooting guide in the manual.
- Contact Woodward technical assistance (see "How to Contact Woodward" later in this chapter) and discuss your problem. In most cases, your problem can be resolved over the phone. If not, you can select which course of action you wish to pursue based on the available services listed in this section.

Returning Equipment For Repair



If a control (or any part of an electronic control) is to be returned to Woodward for repair, please contact Woodward in advance to obtain a Return Authorization Number. When shipping the unit(s), attach a tag with the following information:

- name and location where the control is installed;
- name and phone number of contact person;
- complete Woodward part numbers (P/N) and serial number (S/N);
- description of the problem;
- instructions describing the desired repair.



CAUTION

To prevent damage to electronic components caused by improper handling, read and observe the precautions in Woodward manual 82715, *Guide for Handling and Protection of Electronic Controls, Printed Circuit Boards, and Modules*.

Packing a Control

Use the following materials when returning a complete control:

- protective caps on any connectors
- antistatic protective bags on all electronic modules
- packing materials that will not damage the surface of the unit
- at least 100 mm (4 inches) of tightly packed, industry-approved packing material
- a packing carton with double walls
- a strong tape around the outside of the carton for increased strength

Return Authorization Number RAN

When returning equipment to Woodward, please telephone and ask for the Customer Service Department in Stuttgart [+49 (0) 711 789 54-0]. They will help expedite the processing of your order through our distributors or local service facility. To expedite the repair process, contact Woodward in advance to obtain a Return Authorization Number, and arrange for issue of a purchase order for the unit(s) to be repaired. No work can be started until a purchase order is received.



NOTE

We highly recommend that you make arrangement in advance for return shipments. Contact a Woodward customer service representative at +49 (0) 711 789 54-0 for instructions and for a Return Authorization Number.

Replacement Parts



When ordering replacement parts for controls, include the following information:

- the part numbers P/N (XXXX-XXX) that is on the enclosure nameplate
- the unit serial number S/N, which is also on the nameplate

How To Contact Woodward



Please contact following address if you have questions or if you want to send a product for repair:

Woodward GmbH
Handwerkstrasse 29
70565 Stuttgart - Germany

Phone: +49 (0) 711 789 54-0 (8:00 - 16:30 German time)
Fax: +49 (0) 711 789 54-100
email: stgt-info@woodward.com

For assistance outside Germany, call one of the following international Woodward facilities to obtain the address and phone number of the facility nearest your location where you will be able to get information and service.

Facility	<u>Phone number</u>
USA	+1 (970) 482 5811
India	+91 (129) 409 7100
Brazil	+55 (19) 3708 4800
Japan	+81 (476) 93 4661
The Netherlands	+31 (23) 566 1111

You can also contact the Woodward Customer Service Department or consult our worldwide directory on Woodward's website (www.woodward.com) for the name of your nearest Woodward distributor or service facility. [For worldwide directory information, go to www.woodward.com/ic/locations.]

Engineering Services



Woodward Industrial Controls Engineering Services offers the following after-sales support for Woodward products. For these services, you can contact us by telephone, by e-mail, or through the Woodward website.

- Technical support
- Product training
- Field service during commissioning

Technical Support is available through our many worldwide locations, through our authorized distributors, or through GE Global Controls Services, depending on the product. This service can assist you with technical questions or problem solving during normal business hours. Emergency assistance is also available during non-business hours by phoning our toll-free number and stating the urgency of your problem. For technical engineering support, please contact us via our toll-free or local phone numbers, e-mail us, or use our website and reference technical support.

Product Training is available on-site from several of our worldwide facilities, at your location, or from GE Global Controls Services, depending on the product. This training, conducted by experienced personnel, will assure that you will be able to maintain system reliability and availability. For information concerning training, please contact us via our toll-free or local phone numbers, e-mail us, or use our website and reference *customer training*.

Field Service engineering on-site support is available, depending on the product and location, from our facility in Colorado, or from one of many worldwide Woodward offices or authorized distributors. Field engineers are experienced on both Woodward products as well as on much of the non-Woodward equipment with which our products interface. For field service engineering assistance, please contact us via our toll-free or local phone numbers, e-mail us, or use our website and reference *field service*.

Technical Assistance



If you need to telephone for technical assistance, you will need to provide the following information. Please write it down here before phoning:

Contact

Your company _____

Your name _____

Phone number _____

Fax number _____

Control (see name plate)

Unit no. and revision: P/N: _____ REV: _____

Unit type DTSC- _____

Serial number S/N _____

Description of your problem

Please be sure you have a list of all parameters available. You can print this using LeoPC1. Additionally you can save the complete set of parameters (standard values) and send them to our Service department via e-mail.

We appreciate your comments about the content of our publications.
Please send comments to: stgt-documentation@woodward.com
Please include the manual number from the front cover of this publication.



Woodward GmbH
Handwerkstrasse 29 - 70565 Stuttgart - Germany
Phone +49 (0) 711 789 54-0 • Fax +49 (0) 711 789 54-100
stgt-info@woodward.com

Homepage

<http://www.woodward.com/power>

Woodward has company-owned plants, subsidiaries, and branches, as well as authorized distributors and other authorized service and sales facilities throughout the world.

Complete address/phone/fax/e-mail information
for all locations is available on our website (www.woodward.com).

2010/3/Stuttgart