

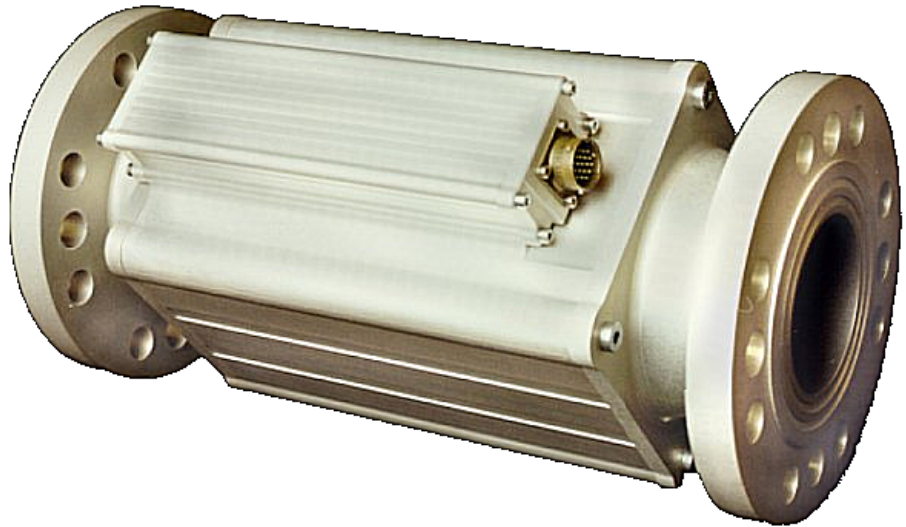

## Installation and Operation Manual



## TecJet™ 50 Gas Control Valve

Manual 36102 (Revision B)

## IMPORTANT



This is the safety alert symbol. It is used to alert you to potential personal injury hazards. Obey all safety messages that follow this symbol to avoid possible injury or death.

## DEFINITIONS

- **DANGER**—Indicates a hazardous situation which, if not avoided, will result in death or serious injury.
- **WARNING**—Indicates a hazardous situation which, if not avoided, could result in death or serious injury.
- **CAUTION**—Indicates a hazardous situation which, if not avoided, could result in minor or moderate injury.
- **NOTICE**—Indicates a hazard that could result in property damage only (including damage to the control).
- **IMPORTANT**—Designates an operating tip or maintenance suggestion.

## WARNING

The engine, turbine, or other type of prime mover should be equipped with an overspeed shutdown device to protect against runaway or damage to the prime mover with possible personal injury, loss of life, or property damage.

The overspeed shutdown device must be totally independent of the prime mover control system. An overtemperature or overpressure shutdown device may also be needed for safety, as appropriate.



Read this entire manual and all other publications pertaining to the work to be performed before installing, operating, or servicing this equipment. Practice all plant and safety instructions and precautions. Failure to follow instructions can cause personal injury and/or property damage.



This publication may have been revised or updated since this copy was produced. To verify that you have the latest revision, be sure to check the Woodward website:

[www.woodward.com/pubs/current.pdf](http://www.woodward.com/pubs/current.pdf)

The revision level is shown at the bottom of the front cover after the publication number. The latest version of most publications is available at:

[www.woodward.com/publications](http://www.woodward.com/publications)

If your publication is not there, please contact your customer service representative to get the latest copy.



Any unauthorized modifications to or use of this equipment outside its specified mechanical, electrical, or other operating limits may cause personal injury and/or property damage, including damage to the equipment. Any such unauthorized modifications: (i) constitute "misuse" and/or "negligence" within the meaning of the product warranty thereby excluding warranty coverage for any resulting damage, and (ii) invalidate product certifications or listings.

## NOTICE

To prevent damage to a control system that uses an alternator or battery-charging device, make sure the charging device is turned off before disconnecting the battery from the system.

## NOTICE

To prevent damage to electronic components caused by improper handling, read and observe the precautions in Woodward manual 82715, *Guide for Handling and Protection of Electronic Controls, Printed Circuit Boards, and Modules*.

Revisions—Text changes are indicated by a black line alongside the text.

Woodward Governor Company reserves the right to update any portion of this publication at any time. Information provided by Woodward Governor Company is believed to be correct and reliable. However, no responsibility is assumed by Woodward Governor Company unless otherwise expressly undertaken.

© Woodward 2001  
All Rights Reserved

# Contents

<b>ELECTROSTATIC DISCHARGE AWARENESS .....</b>	<b>II</b>
<b>CHAPTER 1. GENERAL INFORMATION.....</b>	<b>1</b>
TecJet™ 50 Gas Control Valve.....	1
TecJet 50 Monitoring Software.....	2
Benefits of the TecJet 50.....	2
<b>CHAPTER 2. INSTALLATION.....</b>	<b>3</b>
Environmental Conditions.....	3
Wiring Requirements.....	4
Installation of the TecJet 50.....	7
<b>CHAPTER 3. OPERATION .....</b>	<b>11</b>
Pre-start Checks during Installation .....	11
Configuration of the TecJet 50 .....	11
Installation of the TecJet 50 Monitoring Software .....	12
Description of TecJet 50 Monitoring Program.....	13
Description of the TecJet 50 Menus.....	16
Replacement of TecJet 50 Gas Control Valve .....	21
<b>CHAPTER 4. TROUBLESHOOTING .....</b>	<b>23</b>
Introduction.....	23
Error Codes .....	23
Messages .....	25
<b>CHAPTER 5. TECHNICAL SPECIFICATIONS.....</b>	<b>26</b>
TecJet™ 50 Specifications .....	26
TecJet 50 Flow Capacity .....	27
<b>CHAPTER 6. SERVICE OPTIONS .....</b>	<b>29</b>
Product Service Options.....	29
Woodward Factory Servicing Options.....	30
Returning Equipment for Repair.....	31
Replacement Parts.....	31
Engineering Services.....	32
How to Contact Woodward.....	32
Technical Assistance.....	33
<b>DECLARATIONS.....</b>	<b>35</b>

## Illustrations and Tables

Figure 1-1. TecJet 50 Gas Control Valve.....	1
Figure 2-1. Preparing Shielded Wiring .....	4
Figure 2-2. Shielded Wiring Connection.....	4
Figure 2-3. Correct Wiring to Power Supply.....	5
Figure 2-4. Incorrect Wiring to Power Supply.....	6
Figure 2-5. Single TecJet 50 .....	7
Figure 2-6. Multiple TecJet 50's .....	7
Figure 2-7. TecJet 50 Connector.....	7
Figure 2-8. TecJet 50 External Dimensions (8407-105) .....	9
Figure 2-9. TecJet 50 Wiring Diagram (8407-105).....	10
Figure 3-1. Example of Wiring Connections that Facilitate Monitoring of the TecJet 50 .....	12
Figure 3-2. General TJMON Display .....	13
Figure 3-3. File Menu .....	13

## Illustrations and Tables

Figure 3-4. View Menu .....	14
Figure 3-5. Parameters Menu.....	15
Figure 3-6. Diagnostics Menu.....	15
Figure 3-7. Help Menu.....	16
Figure 5-1. Flow Capacity for the TecJet 50, Version 1 .....	27
Figure 5-2. Flow Capacity for the TecJet 50, Version 2 .....	28
Figure 5-3. Flow Capacity for the TecJet 50, Version 3 .....	28

## Electrostatic Discharge Awareness

All electronic equipment is static-sensitive, some components more than others. To protect these components from static damage, you must take special precautions to minimize or eliminate electrostatic discharges.

Follow these precautions when working with or near the control.

1. Before doing maintenance on the electronic control, discharge the static electricity on your body to ground by touching and holding a grounded metal object (pipes, cabinets, equipment, etc.).
2. Avoid the build-up of static electricity on your body by not wearing clothing made of synthetic materials. Wear cotton or cotton-blend materials as much as possible because these do not store static electric charges as much as synthetics.
3. Keep plastic, vinyl, and Styrofoam materials (such as plastic or Styrofoam cups, cup holders, cigarette packages, cellophane wrappers, vinyl books or folders, plastic bottles, and plastic ash trays) away from the control, the modules, and the work area as much as possible.
4. Do not remove the printed circuit board (PCB) from the control cabinet unless absolutely necessary. If you must remove the PCB from the control cabinet, follow these precautions:
  - Do not touch any part of the PCB except the edges.
  - Do not touch the electrical conductors, the connectors, or the components with conductive devices or with your hands.
  - When replacing a PCB, keep the new PCB in the plastic antistatic protective bag it comes in until you are ready to install it. Immediately after removing the old PCB from the control cabinet, place it in the antistatic protective bag.

### NOTICE

To prevent damage to electronic components caused by improper handling, read and observe the precautions in Woodward manual 82715, *Guide for Handling and Protection of Electronic Controls, Printed Circuit Boards, and Modules*.

# Chapter 1.

## General Information

### TecJet™ 50 Gas Control Valve

The TecJet™ 50 is an electronic gas injection valve for single point injection that integrates sensors and electronics. The TecJet 50 valve ensures correct gas flow under all circumstances.

Working in conjunction with an engine management system, such as the Woodward EGS-01, the TecJet 50 receives the signal indicating the desired gas flow and gas density from the engine management system. The engine management system will monitor the load and speed of the engine and provide the TecJet with the gas flow signals accordingly.

The microcomputer situated inside the TecJet 50 will convert the desired gas flow signal into a valve position that directly corresponds to the desired gas flow. The valve position will also be adjusted for such variables as:

- Gas inlet pressure
- Gas temperature
- The pressure over the valve
- The density of the gas

The TecJet 50, in combination with an engine control system, forms an ideal solution to gas engine control, regardless of gas specification (pressure, temperature, and composition).

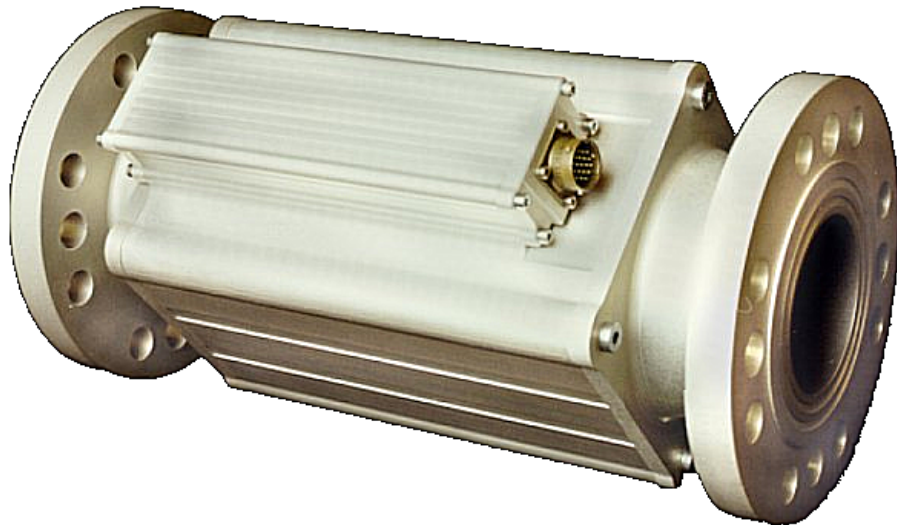

Figure 1-1. TecJet 50 Gas Control Valve

**IMPORTANT**

The TecJet 50 gas control valve is suitable for gas engine applications within the power range of 200–2000 kW (depending on gas pressure and composition).

**IMPORTANT**

In the case of variation in gas flow demand, the TecJet 50 gas control valve is able to respond extremely quickly. The benefits of such fast response result in good engine behavior—low fuel consumption, accurate emission levels, and gas flow that completely matches load demand. The TecJet 50 can easily be installed and monitored using a PC and the TecJet 50 software.

## TecJet 50 Monitoring Software

The TecJet 50 monitoring software provides user-friendly installation and adjustment of the TecJet 50, via your PC. In addition the monitoring software fulfills the following functions:

- Setting configuration parameters
- Monitoring the status of the TecJet 50
- Tracking gas output variables

For more information on the installation and function of the TecJet 50 monitoring software, see Chapter 3 (Operation).

## Benefits of the TecJet 50

The TecJet 50 revolutionizes gas engine fuel control, increasing the possible applications of gas engines and ensuring safe and effective operation, regardless of gas composition.

Advantages of installing the TecJet 50 intelligent fuel metering system, in conjunction with an engine management system, are:

- Integrated sensors and electronics
- Extremely fast response to flow commands
- Microprocessor-based mass gas flow control
- Accurate over the entire gas flow range
- Highly accurate gas metering device
- Compensates for fluctuations in both gas temperature and gas pressure (density)
- Bi-directional communication performed by CAN bus
- Requires only analog or digital signal stating the desired gas flow and supply voltage to instigate correct valve positioning with regards to desired gas flow

The Woodward EGS-01 engine management system forms the ideal gas control partnership with the TecJet 50 gas control valve. However, the TecJet 50 is suitable to work in conjunction with the complete range of available engine management systems.

## Chapter 2. Installation

### NOTICE

The TecJet™ 50 contains electrostatic-sensitive components which can be damaged by static electricity from the human body. Before you install the TecJet 50, read the Electrostatic Discharge Awareness precautions on page ii, and discharge the static electricity on your body to ground.

### Environmental Conditions

These environmental conditions must be met when installing or running a TecJet 50:

#### Ambient Operating Temperature

The TecJet 50 must be operated within a temperature range of  $-20$  to  $+85$  °C ( $-4$  to  $+185$  °F), although the TecJet 50 will survive a soak temperature of  $105$  °C ( $221$  °F) caused by engine shutdown.

#### Storage Temperature

The TecJet 50 must be stored without power applied within a temperature range of  $-40$  to  $+100$  °C ( $-40$  to  $+212$  °F).

#### Gas Temperature

The TecJet 50 requires a regulated gas temperature in the range of  $30$ – $60$  °C ( $86$ – $140$  °F).

#### Humidity

The TecJet 50 requires an ambient relative humidity from 0% to 95%, non-condensing. The maximum level of relative humidity of the gas that is processed by the valve is 80%.

#### Mechanical Shock and Vibration

The TecJet 50 is designed to withstand vibration and shock according to the following standards:

Vibration, Swept Sine, SV3	5G, 2.5 mm, 5–2000 Hz, 3 h min/axis, 90 min dwells MS 810C, M514.2, Curve J (Mod)
Vibration, Random, RV2	0.1 G <sup>2</sup> /Hz, 10–2000 Hz, 3 h/axis, 12.8 Grms MS202F, Method 214A, Test Condition D
Shock, MS1	40 G, 11ms sawtooth Pulse US MIL-STD-810C, M516.2, PI

**Electromagnetic Compatibility**

The TecJet 50 complies with the electromagnetic emissions and immunity requirements as specified below:

- EN 61000-6-4, Emission Criteria
- EN 61000-6-2, Immunity Criteria (see Note)

<b>IMPORTANT</b>	<p>The power for the TecJet 50 must be provided from a protected power source that is compliant with the requirements of EN 61000-6-2. The output of the power source must limit the common mode transients caused by surge transients to less than 50 volts. The I/O cabling for the TecJet 50 should be limited to less than 30 meters in length. The TecJet 50, combined with the power supply and cable limitation, will comply with the requirements of EN 61000-6-2 and allow the system containing the TecJet 50 to be compliant with the EMC Directive.</p>
------------------	---

**Wiring Requirements**

**Shielded Wiring**

- Use shielded wires for the signal lines to prevent interference from other electrical equipment (see Figure 2-1).
- Prepare the shielded wires as shown in Figure 2-1.
- Connect the shield to the nearest chassis ground, leaving the opposite end of the shield open. Ensure that the shield is properly insulated (see Figure 2-2).
- Do not install shielded wires directly next to high-current wires.

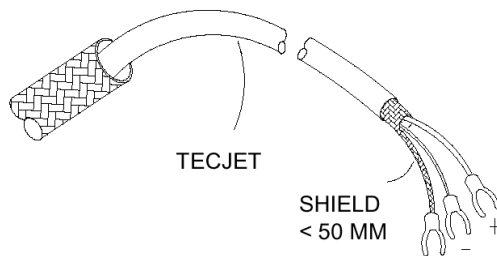

Figure 2-1. Preparing Shielded Wiring

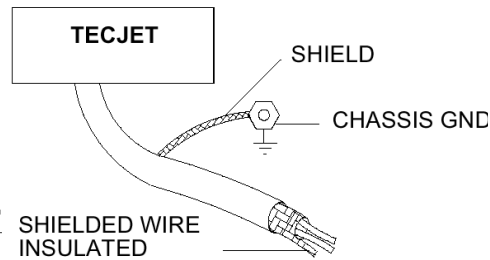

Figure 2-2. Shielded Wiring Connection

**Cable Length Requirements**

Signal Type	Signal Details	Max. Cable Length
Analog	0–5 Vdc	15 m (49 ft)
PWM	75–150 Hz	15 m (49 ft)
DPWM	75–150 Hz	15 m (49 ft)
CAN	125 Kbits/s	530 m (1739 ft)
CAN	250 Kbits/s	270 m (886 ft)
CAN	500 Kbits/s	130 m (427 ft)
CAN	1 Mbit/s	40 m (131 ft)
RS-232	9600 bits/s	15 m (49 ft)
ISO9141	9600 bits/s	15 m (49 ft)



### Electrical Connections

See the wiring diagram (Figure 2-9) for complete details of electrical connections to the TecJet 50.

For detailed information concerning the different signal inputs (Analog, PWM, Dual PWM (DPWM), CAN, CAN & PWM, EGS, and C28), see the Description of the TecJet 50 Menu section in Chapter 3.

### Power Supply Requirements

The input power supply to the TecJet 50 is rated at 18 to 32 Vdc, 24 Vdc nominal. It is protected from reverse voltage connections and up to +80 V on its input. The following internal voltages are generated:

- +5 Vdc  $\pm 5\%$  @ 400 mA max. non-isolated
- +13 V  $\pm 10\%$  @ +40 mA non-isolated
- -13 V unregulated @ -3 mA non-isolated

See Figures 2-3 and 2-4 for details on correct power supply wiring for the TecJet 50.

## **WARNING**

The TecJet 50 must be fused. Failure to fuse the TecJet 50 could, under exceptional circumstances, lead to personal injury, damage to the control valve and/or explosion.

## **NOTICE**

Do not power other devices with leads common to the TecJet 50, and avoid long wire lengths.

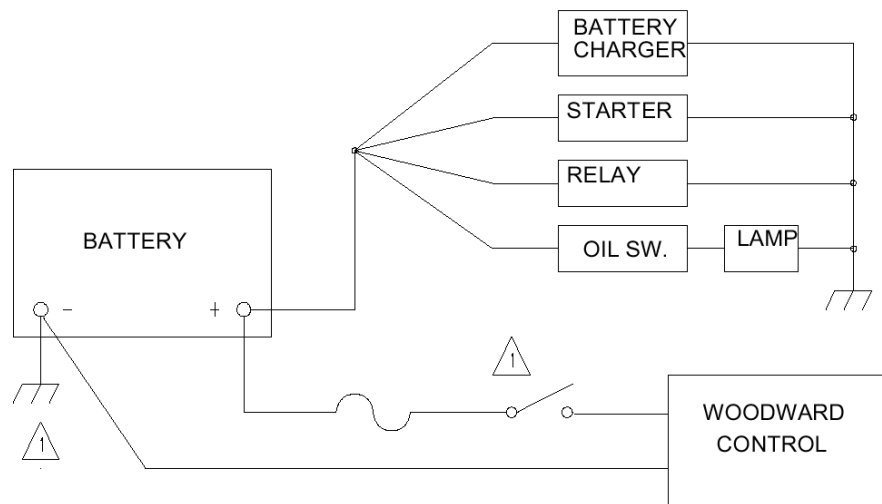

Figure 2-3. Correct Wiring to Power Supply

## **IMPORTANT**

Power must provide transient protection (see Electromagnetic Compatibility earlier in this chapter).

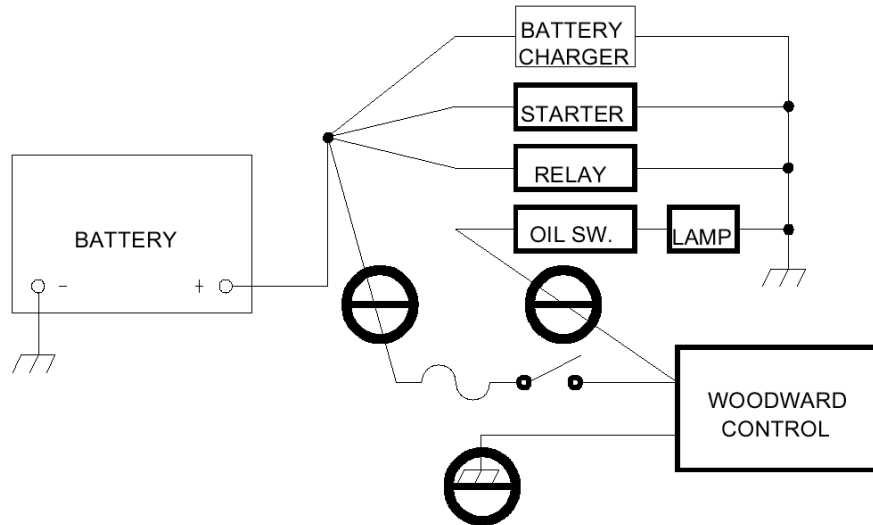

Figure 2-4. Incorrect Wiring to Power Supply

## NOTICE

A negative ground system is shown. If a positive ground system is used, the switch and control fuse must be located in series with the battery (-) and the terminal on the Woodward control. The positive terminal becomes chassis ground.

## IMPORTANT

If the TecJet 50 is installed in combination with an EGS-01 engine control, the TecJet 50 will take the power supply from the EGS-01 engine control.

### Termination Resistor for CAN Communication

If CAN communication is used between the TecJet 50 and the engine control system, a termination resistor of 120 W between pin B and pin S must be installed on the TecJet 50 (see Figure 2-5). The termination resistor on the TecJet 50 connector will prevent disturbances and/or reflections of CAN signals.

If your application consists of multiple TecJet 50's, then pins B and S of the first TecJet 50 should be connected to pins N and V of the second TecJet 50. Connect the termination resistor between pins B and S of the second TecJet 50. For further details, see Figures 2-6 and 2-9.

## IMPORTANT

The termination resistor must always be connected through pins B and S of the last TecJet 50 in an application using multiple TecJet 50's. See Figure 2-6 for further details.

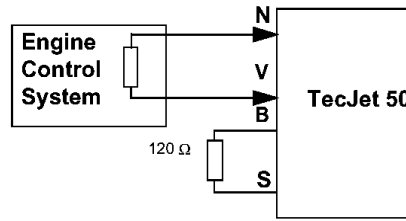

Figure 2-5. Single TecJet 50

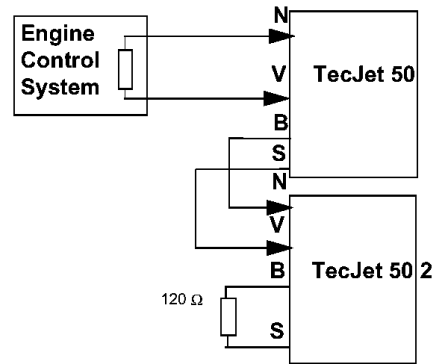

Figure 2-6. Multiple TecJet 50's

- N CAN High In
- B CAN High Out
- C CAN Coding ID's \*
- H PWM-B / CAN Coding ID's \*
- S CAN Low Out
- V CAN Low In

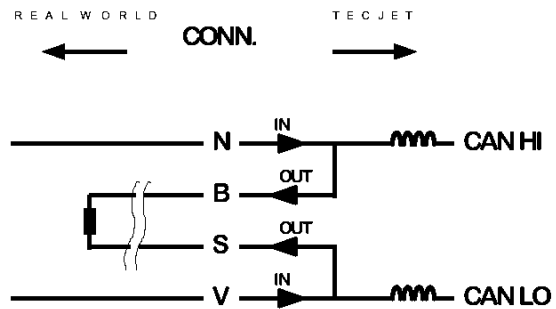

Figure 2-7. TecJet 50 Connector

\* See Figure 2-9 for further details on CANDID harness coding.

### Installation of the TecJet 50

**IMPORTANT** The TecJet 50 can be installed upstream or downstream of the turbocharger. However, installation of the TecJet 50 downstream of the turbocharger is only possible if the boost pressure is less than 200 kPa (29 psi).

**NOTICE** Ensure that all dirt has been blown out of the gas stream, upstream of the TecJet 50, before installing the TecJet 50 gas control valve. The pre-fitted TecJet 50 filter is only for the purpose of filtering welding deposits and Teflon tape particles during the initial start-up.

**NOTICE** Before installation of the TecJet 50 to the gas pipe, prepare the gas pipe with two flanges which are the same size as the flanges on the TecJet 50 (see Figure 2-8) for further details.

Installation of an upstream filter is highly recommended for all applications. The preferred TecJet 50 filter is 50 µm.

- Install the TecJet 50 between the two flanges that are fitted onto the gas pipe (see Figure 2-8).
- Place a gasket between the TecJet 50 flange and the flange on the gas pipe.
- Connect the TecJet 50 flange to the flange on the gas pipe on both sides, according to DIN 2501 (DN80, PN 10/16) for Europe, or to ANSI B (16,5 3", 125/150 lb) for North America (see Figure 2-8).
- The TecJet 50 should preferably be supported using a bracket. Use the four screw holes (M8x16) located at the bottom of the housing to install the TecJet 50.

**IMPORTANT**

The TecJet 50 must be installed horizontally, with the electronics at the top-side, and the connector located at the outlet side of the valve. The centerline of the TecJet 50 should be parallel to the centerline of the crankshaft in order to avoid severe vibration levels in the moving direction of the TecJet 50 metering piston (see Figure 2-8).

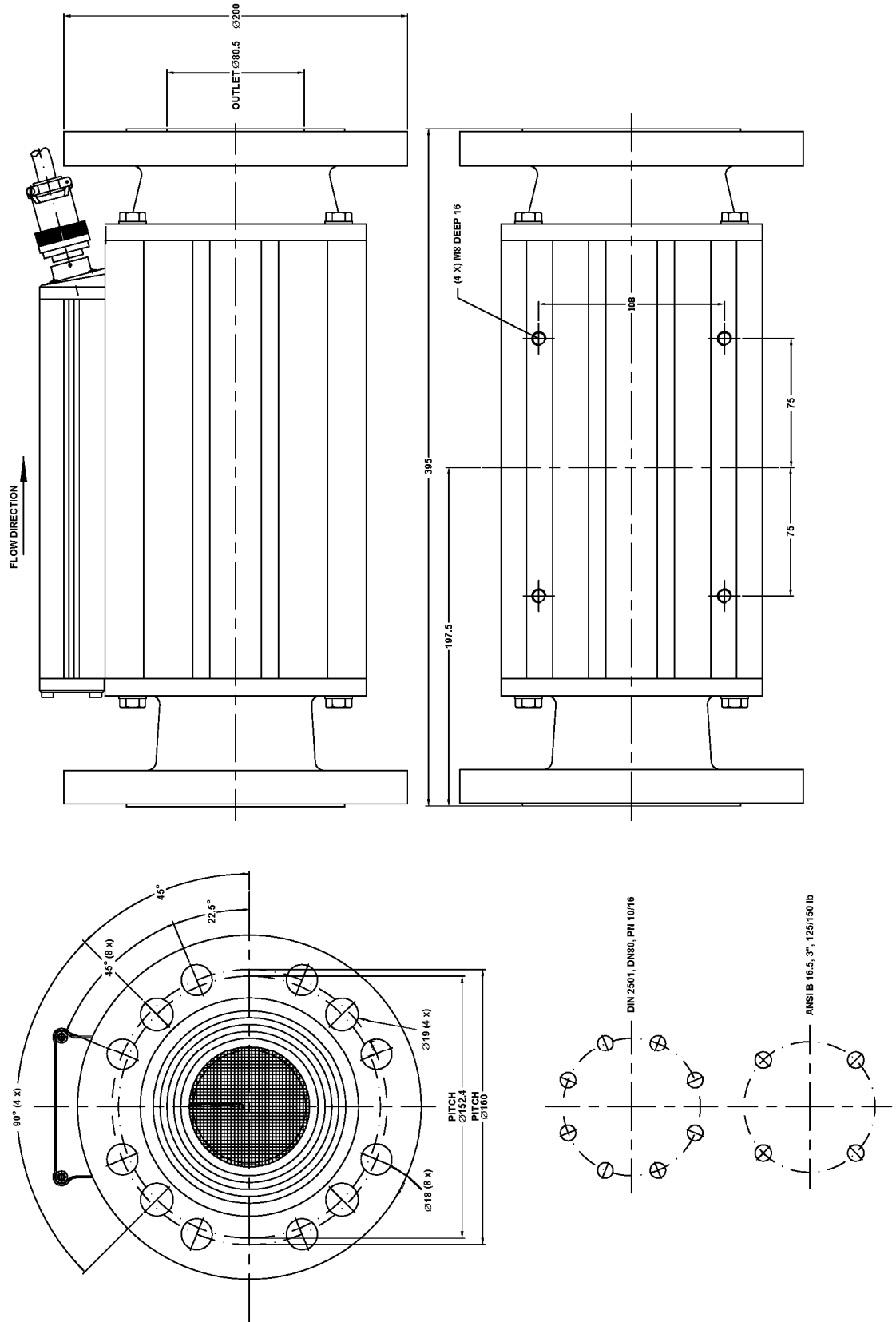
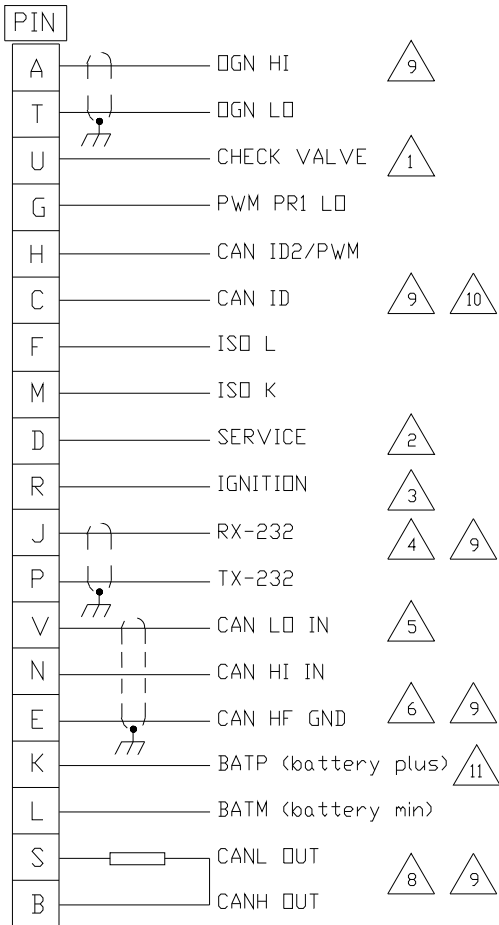

Figure 2-8. TecJet 50 External Dimensions (8407-105)

All wires min. 0.5 mm<sup>2</sup> except battery wires.



- 1 Pull down, max. 20 mA, 1 kilohm
- 2 Connected to ground = service mode  
Open = normal
- 3 6 - 32 Vdc = fuel on  
0 - 6 Vdc = fuel off
- 4 Communication port RS-232
- 5 CAN port
- 6 Connect CAN HF GND in case of high CAN speed signals and to reduce EMC interference.
- 7 Layout when two TecJets in operation
- 8 Termination resistor for CAN communication has to be 120 ohm on both ends of the bus.
- 9 Connect the shields to the nearest ground. Wire exposed beyond the shield should be as short as possible, not exceeding 50 mm (2 inches). The other end of the shield must be left open and insulated from any other.
- 10 Harness coding for CAN bus:
 

CAN ID	OC	LOW	OC	LOW
CAN ID2	OC	OC	LOW	LOW
TecJet	1	2	3	4

 where OC = left floating  
pulled LOW to circuit common (BATM)
- 11 See Chapter 2, Electromagnetic Compatibility.

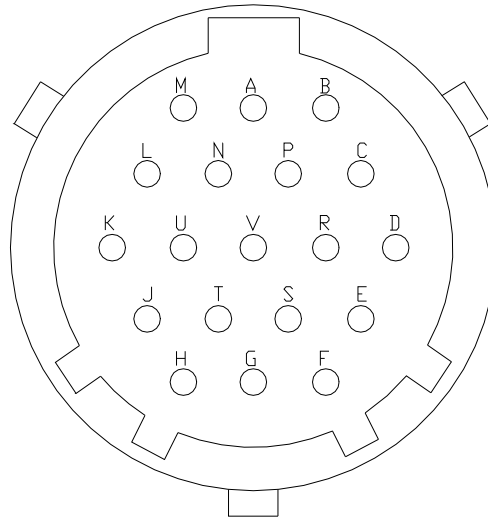
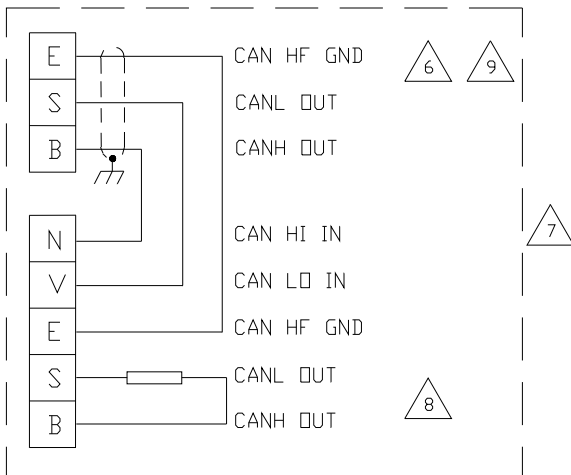
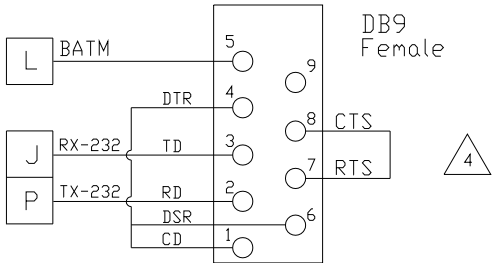

361-007  
02-12-11

Figure 2-9. TecJet 50 Wiring Diagram (8407-105)

## Chapter 3. Operation

### Pre-start Checks during Installation

Be sure to complete these steps before you start the engine:

- Check for correct wiring (see Figure 2-9).
- Check the TecJet™ 50 for signs of damage, and broken or loose connections. Make any necessary repairs to the TecJet 50.
- Check the connection between the flange of the TecJet 50 and the flange used by the engine manufacturer, on both sides of the connection. Check for gas leakages from the connection and, if necessary, also from the TecJet 50 (only in the case of repair and/or maintenance of the valve).
- Always ensure that the TecJet 50 is installed using a bracket. Also check the connection between the bracket and the TecJet 50.
- Check that the TecJet 50 is installed in the correct direction according to the gas flow.
- Check that you have selected the correct communication interface for your TecJet. This is visible in the “FLOW INPUT” window of the TecJet 50 monitoring program. It is in this manner that you are able to communicate with your engine management system.

### Configuration of the TecJet 50



**Be prepared to make an emergency shutdown when starting the engine, turbine, or other type of prime mover, to protect against runaway or overspeed with possible personal injury, loss of life, or property damage.**

- Connect a PC to the TecJet 50 (see the next section, Installation of the TecJet 50 Monitoring Software) to configure your TecJet 50. If necessary, contact Woodward for details of your parameter settings. For instructions on how to use the TecJet 50 Monitoring system, see the section Description of TecJet 50 Monitoring Program later in this chapter. For more information about the TecJet 50 Monitoring system, see the TecJet 50 Monitoring Help File.
- Apply power to the TecJet 50.

Adjust the following application specific parameters of your TecJet 50 before you start the engine:

<b>Window</b>	<b>Adjustment</b>
Fuel Parameters Window	Adjust the Density of the gas. Adjust the "Wobbe index act. gas" and the "Wobbe index ref. gas". Both Wobbe indexes must be equal to each other and set to the Wobbe index of the current gas supply to the engine.
Default Tables Window	Adjust the "Qgn", "Delta P", "FGP", and "FGT" parameters, if desired.
CAN interface Window	Adjust the CAN interface parameters.
PH-Limits Window	Adjust the physical limits for "Delta P", "FGP", and "FGT", if desired.
Version Info Window	Check if the right TecJet 50 and Co-processor are loaded. Check the ROM parameter set.
Flow Input Window	Select the type of communication, and set U0 and U1 to the number of counts for your application. See table below.
	Type U0 / U1
	Analog 0—1023
	PWM PWM signal varies between the 5% (224) and 95% (3910) counts
	DPWM 0—4095
	CAN 0—65536

Start the engine according to the engine manufacturer's instructions.

### Installation of the TecJet 50 Monitoring Software

Load the TecJet 50 software onto your PC:

1. Connect the laptop with cable to the PC connector, which is connected to the TecJet 50 connector. This will enable monitoring of the TecJet 50.
2. Insert the "TecJet 50 Software" disk into your drive A.
3. Start MS-DOS or the Window Explorer and go to drive A to copy the TecJet 50 files.
4. Copy the files Tjmon.exe, Tjmon.c16, and Tjmon.h16 to your personal directory.
5. Go to the Tjmon.exe file and press Enter or double click. The TJMON display will appear on the screen, as shown in Figure 3-2.
6. Go to the "Flow Input" window and select the type of flow command for your TecJet 50 (Analog, PWM, CAN, etc.).

Having loaded the monitoring program onto your PC, proceed by following the on-screen instructions. For further explanation of the TecJet 50 monitoring program, see the following section, Description of TecJet 50 Monitoring Program.

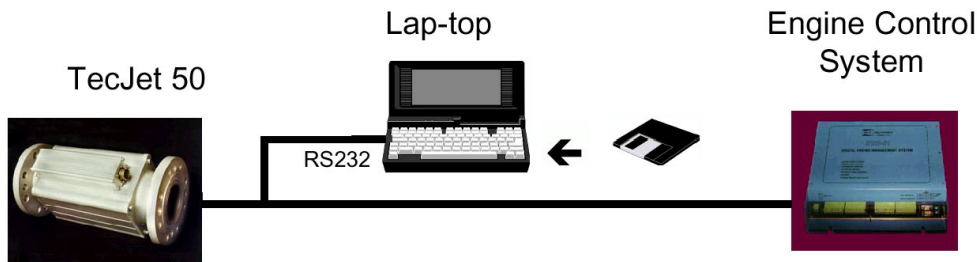

Figure 3-1. Example of Wiring Connections that Facilitate Monitoring of the TecJet 50



## Description of TecJet 50 Monitoring Program

If you have opened the Tjmon.exe file, the TJMON display will appear on your screen (see Figure 3-2). The menu bar on the TJMON display provides a set of commands and settings to allow monitoring and configuring the TecJet 50 gas control valve. Each menu contains several options that are commands, or links to further menus.

The menu bar consists of the following menus (see the appropriate section for a brief overview):

- “File” menu
- “View” menu
- “Parameters” menu
- “Diagnostics” menu
- “Help” menu

For further details of each menu option, see the following section, Description of the TecJet 50 Menus.

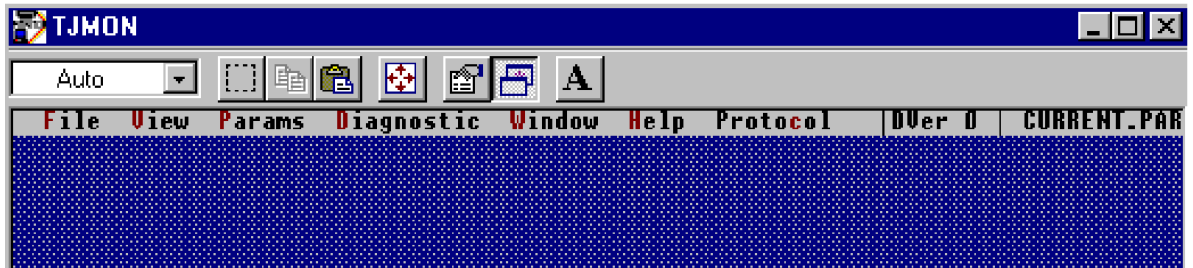

Figure 3-2. General TJMON Display

### File Menu

The File menu contains standard options for saving or retrieving parameter files (see next section for more details).

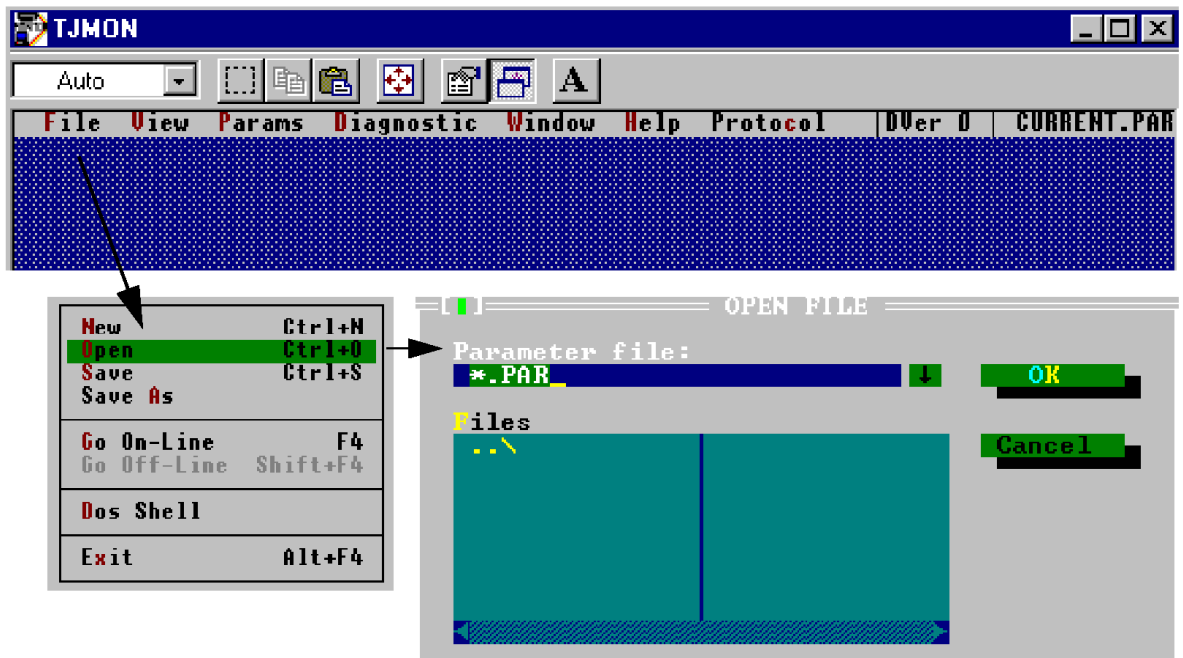

Figure 3-3. File Menu

**View Menu**

The “View” menu allows you to view the output parameters contained in the system. These can be either running levels or error conditions (see next section for more details).

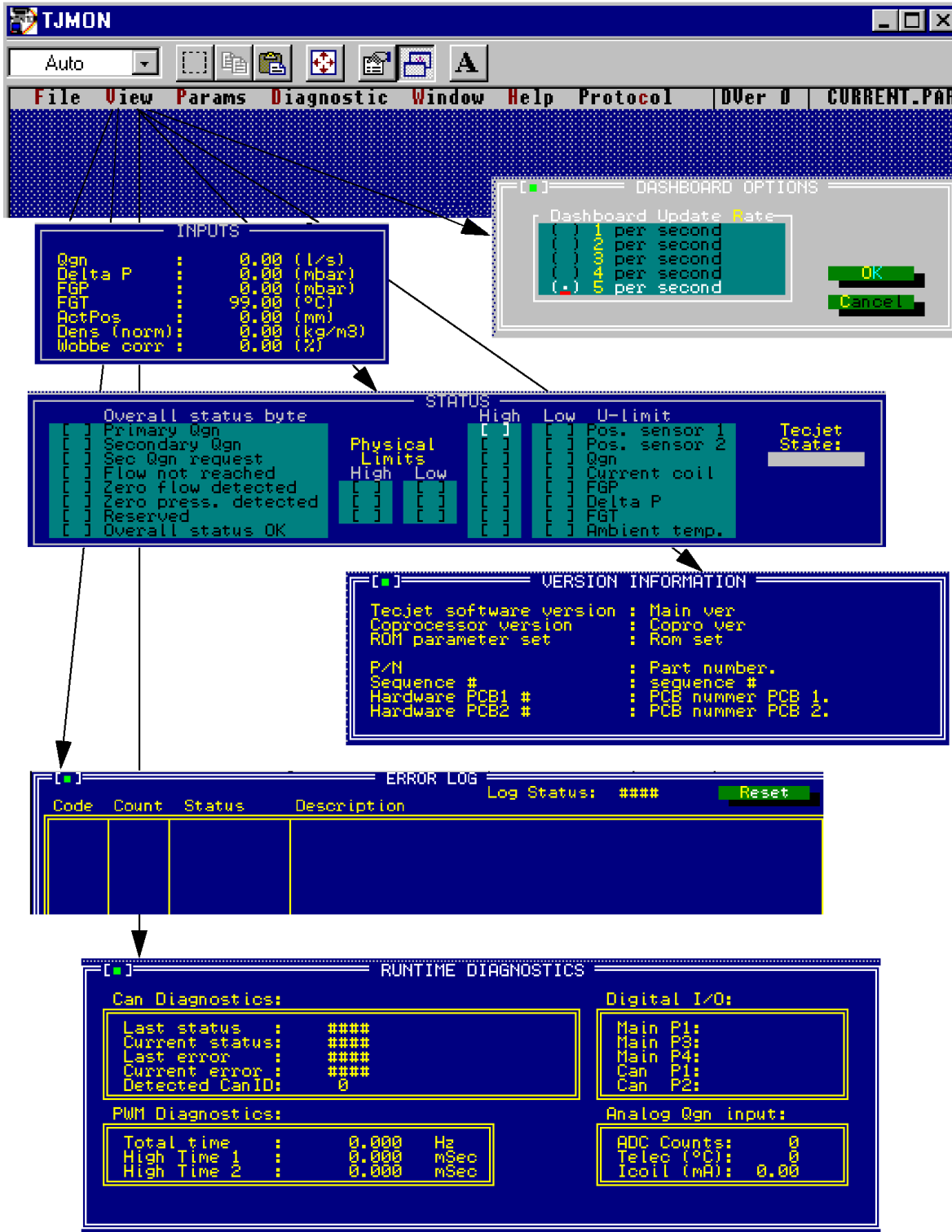

Figure 3-4. View Menu

**Parameters Menu**

The “Parameters” menu contains windows into which you are able to enter and modify the various fuel, flow or CAN parameters (see next section for more details).

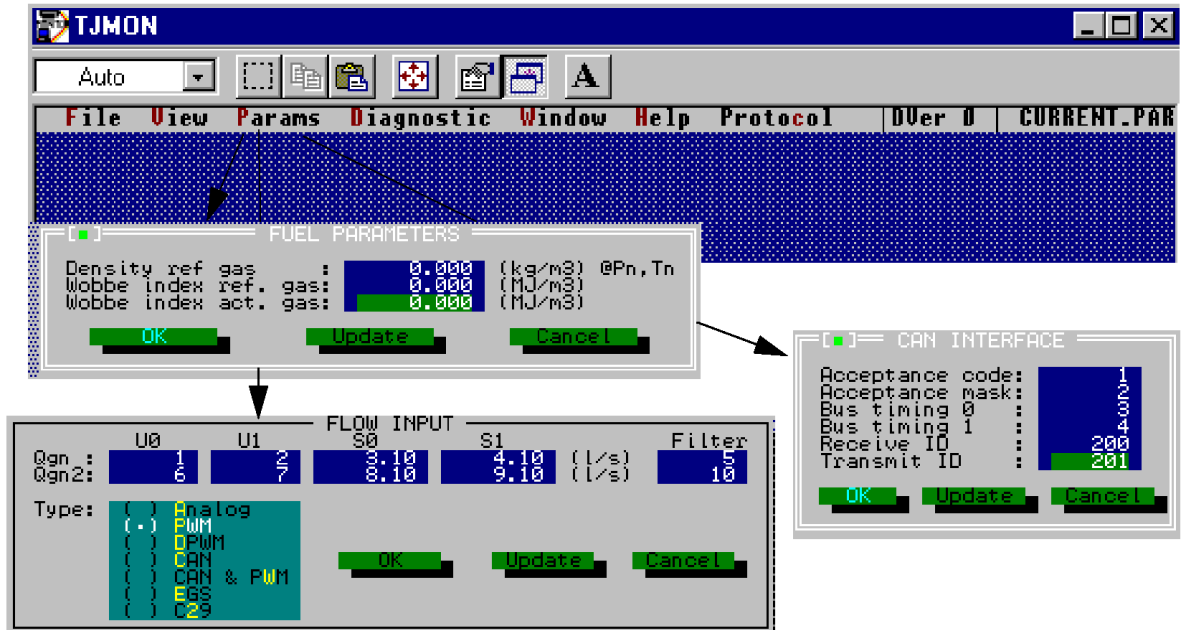

Figure 3-5. Parameters Menu

**Diagnostics Menu**

The “Diagnostics” menu provides you with the ability to access information on default tables and physical limitations (see next section for more details).

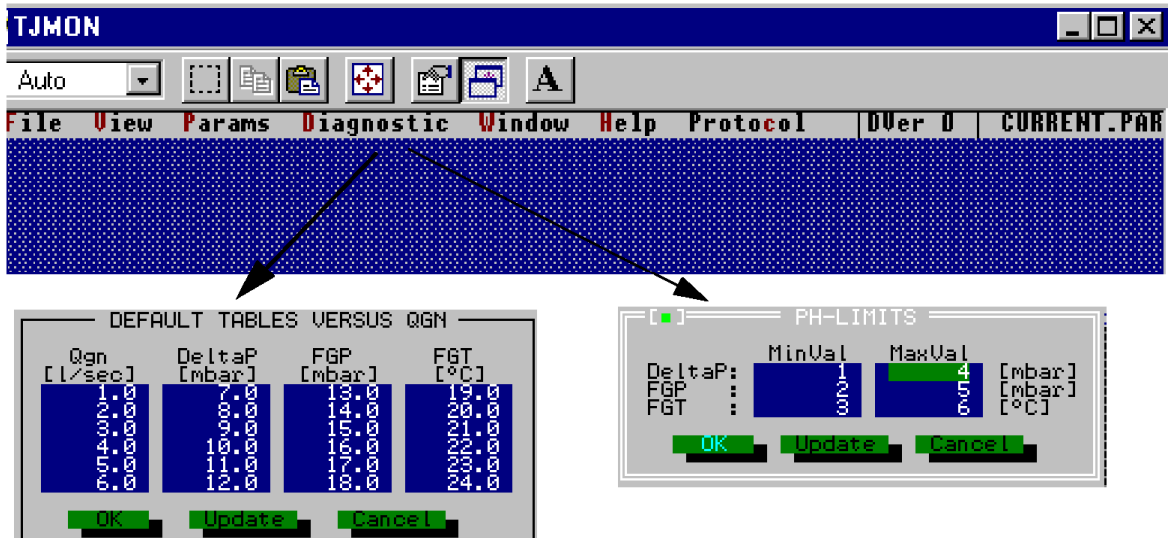

Figure 3-6. Diagnostics Menu

**Help Menu**

The Help menu is divided in two windows: “Contents” window and “Context sensitive” window. The main part of this window is used to display help information about relevant topics.

The “Contents” window gives a brief introduction to the application.

The “Context Sensitive” window provides you with information that assists you in the action that you are currently performing.

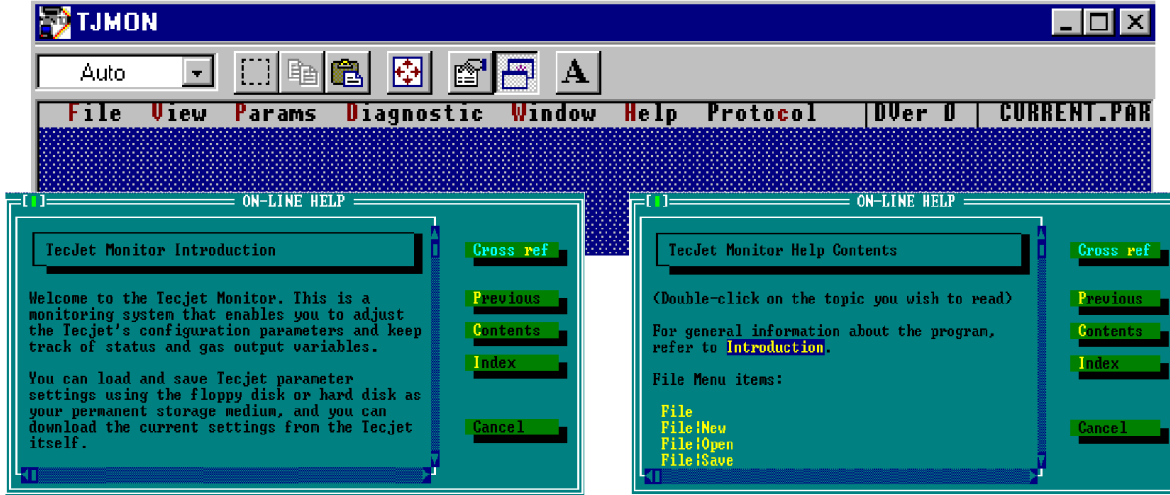

Figure 3-7. Help Menu

**Description of the TecJet 50 Menus**

Menu / Window	Parameter	Function
<b>File Menu</b>	Open	To retrieve a saved set of parameter settings from the disk, select “Open” from the File menu.
	Save	To store the TecJet 50 parameter settings to disk, select “Save” from the file menu.
	Save As	To make a new parameter file on disk, select “Save As” from the File menu.
	New	Permits you to reset the current parameter settings to their default as encoded in the software.
	DOS Shell	If you want to go to DOS, select “DOS” from the file menu so that the normal window disappears. Type “exit” to return to your TJMON display.
	Exit	If you want to quit the application, select “Exit” from the File menu.
<b>View Menu/ Flow Inputs</b>	Qgn	Normal gas flow, at ref. conditions (0 °C/32 °F, 1013 mbar).
	Delta P	Equals the absolute pressure differential over the valve (mbar).
	FGP	Fuel gas pressure (absolute) [mbar].
	FGT	Fuel gas temperature [°C].
	Act Pos	Actual valve position [mm].
	Dens (norm)	Normal gas density 0 °C, 1013 mbar [kg/m³].
	Wobbe corr	The Wobbe corr. corrects on the gas flow, when the Wobbe index act. is higher or lower than the Wobbe index ref., so that the energy flow stays the same. <b>Example:</b> Wobbe Corr. = Wobbe index ref. = 40 / Wobbe index act = 50. In this case the Wobbe index act is 20% higher, which means that you have to lower the gas flow with 20% to remain the same energy flow. Qg (calculated gas flow) = Qg (based of ref. Wobbe) * Wobbe Corr.

Menu / Window	Parameter	Function
View Menu/ Status Window	Primary Qgn	The Primary Qgn activates when the TecJet 50 detects a valid signal from the gas flow command.
	Secondary Qgn	Backup for systems with CAN and PWM connection. If secondary Qgn activates, there is no CAN communication from the TecJet 50.
	Sec Qgn Request	Reserved.
	Flow not Reached	The Flow not reached signal activates when the valve position has reached its maximum stroke. In many cases the Flow not reached signal activates due to one of the following causes: <ul style="list-style-type: none"> <li>• The gas pressure in the supply system is too low.</li> <li>• Pollution in the main gas filter is causing pressure to drop.</li> <li>• The gas temperature is too high.</li> <li>• The quality of the gas (combustion value) is too low and causes an increase of gas supply.</li> <li>• Delta P over the TecJet 50 is too small.</li> </ul>
	Zero Flow Detected	Zero flow set point detected. When the Qgn (set-point) drops under the 0.5% of the Qgn (max.). The valve will then close and the flag is set. The valve opens when the Qgn (set-point) is above 0.7% of the Qgn (max.). For this reason Qgn (max.) is adjusted at maximum flow. Qgn (max.) is the S1 register in the flow inputs menu.
	Zero Pressure Detected	The Zero press. detected activates when the Delta P pressure over the valve is < 3 mbar and then closes the valve. The valve opens if the Delta P becomes > 6 mbar.
	Reserved	No function.
	Overall Status OK	Will activate when the TecJet 50 is within its operating environment (primary Qgn is on and all other flags are off).
	Pos Sensor 1 U-limit Pos Sensor 2 U-limit	The Pos sensor 1 or Pos sensor 2 detects that the actual fuel valve position is out of range (U-limit is reached) that results in a High or Low U-limit flag on the "STATUS" menu. Normally both sensors are used. If one sensor fails, it is switched off and all functions are transferred to the good sensor.
	Qgn U-limit	The Qgn (set-point) input is out of range (U-limit is reached) which results in a High or Low U-limit flag on the "STATUS" menu.
	Current Coil U-limit	If the current though the coil is higher than the maximum or lower than the minimum, the flag will activate. Min. current = -2.4 A Max. current = +2.4 A
	FGP U-limit	The FGP sensor detects that the absolute inlet gas pressure is out of range (U-limit is reached) which results in a High or Low U-limit flag becoming visible on the "STATUS" menu.
	Delta P U-limit	The Delta P sensor detects that the outlet to inlet pressure differential is out of range (U-limit is reached) which results in a High or Low U-limit flag becoming visible on the "STATUS" menu.
	FGT U-limit	The FGT sensor detects that the fuel gas temperature is out of range (U-limit is reached), which results in a High or Low U-limit flag on the "STATUS" menu.
	Ambient Temp U-limit	Reserved.
	Physical Limits	If the Physical Limits shows a High or Low flag for the parameters Delta P, FGP, or FGT, then the parameter is under the min. value or above the max. value as adjusted in the Physical Limits under the Diagnostics menu.
TecJet 50 State	Gives the internal condition of the TecJet 50 software. If you have any problems with your TecJet 50, please mention this code to Woodward.	

**IMPORTANT**

If one of the failures occurs as mentioned above, the TecJet 50 will use the information as stored in the Default tables under Diagnostics menus for the FGP, FGT, and Delta P.

Menu/Window	Parameter	Function
<b>View Menu/ Option Window</b>		In the option window you can specify how many times per second the information in the windows is updated with the actual parameters.
<b>View Menu/ Error Log</b>	Error Log	The "Error log" window gives an overview of all the faults that are found by the diagnostics in the TecJet 50. For every fault, a code with a description is given and if the fault is still actual. Please refer to Chapter 4 for further details on error codes.
<b>View Menu/ Runtime Diagnose</b>	Runtime Diagnostics	The "Runtime diagnostics" window gives an overview of what the status of the hardware is at a very low level.
<b>Parameters Menu / Fuel Parameters Window</b>	Density Ref. Gas	The Density ref. gas lets you specify the gas density. The TecJet 50 uses this parameter in the calculation of the gas flow (Qg) from the "normal" gas flow (Qgn).
	<b>Wobbe Index</b>	The Wobbe index is a measure of the amount of energy delivered to a combustion system via an injector. The energy input is a linear function of the Wobbe index. Two gases of different composition but having the same Wobbe index will deliver the same amount of energy for any given TecJet 50 under the same injector pressure.
	Wobbe Index Ref. Gas	The Wobbe index of the gas used for the engine and the engine management system for optimization.
	Wobbe Index Act. Gas	The Wobbe index of the actual gas the engine is running on.

<b>IMPORTANT</b>	<p><b>Gas density is directly related to the Wobbe index ref. gas.</b></p> <p><b>These Wobbe values will always be set equal since the Wobbe index act. gas valve was for development purposes only.</b></p>
------------------	--

Menu/Window	Parameter	Function
<b>Parameters Menu/ Flow Input Window</b>		<p>The "Flow Input Window" contains the commands that are used to establish which connection is used to determine the flow input type. You must make a selection from this window to supply the TecJet 50 with gas flow.</p> <p>The flow input represents the normalized gas flow in liters per second. The input type selection can be made using the TecJet 50 monitoring program. There are six types of input:</p> <ul style="list-style-type: none"> <li>• Analog            0–5 Volt input</li> <li>• PWM              Pulse width modulated input</li> <li>• DPWM            Pulse width modulated inputs with two six-bit signals</li> <li>• CAN                CAN communication word format</li> <li>• CAN &amp; PWM      CAN communication word format with pulse width modulated backup</li> <li>• EGS                CAN communication float format EGS standard</li> </ul> <p>The Sensors Scaling Dialog contains scaling factors that convert the Analog A/D values to the proper SI units. Each line contains the four required scaling factors for scaling the analog signal. U0 and U1 specify the input range in counts, S0 and S1 specify the corresponding output signal in SI units (L/s).</p>

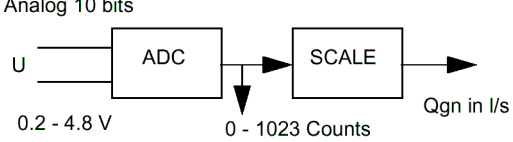
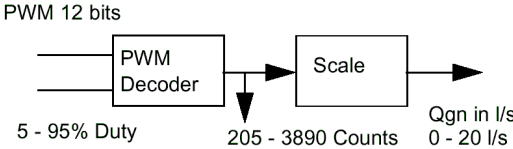
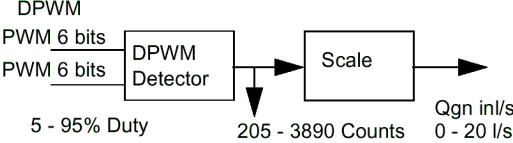
Menu/Window	Parameter	Function
Parameters Menu/ Flow Input Window	Analog	<p>The analog signal from 0.2–4.8 V goes through a 10-bit ADC (analog-to-digital converter) that converts the signal to 0–1023 counts. The ADC sends the 0–1023 counts signal to the scale decoder, which specifies the minimum and maximum counts U0 and U1, and the corresponding minimum and maximum output signal S0 and S1 in L/s (liters per second).</p> <div style="text-align: center;">  <p>Analog 10 bits</p> <p>U ———&gt; [ ADC ] ———&gt; [ SCALE ] ———&gt; Qgn in l/s</p> <p>0.2 - 4.8 V                      0 - 1023 Counts</p> <p>0.2 V → 0 Counts → 0 l/s                  2.5 V → 512 Counts → 10 l/s                  4.8 V → 1023 Counts → 20 l/s</p> </div> <p><b>i</b> S1 is always adjusted at maximum gas flow in relation with zero flow detected.</p>
	PWM	<p>The 12-bit PWM (pulse width modulation) signal passes through a PWM decoder that converts it to 0–4095 counts. The PWM decoder sends the 0–4095 counts to the scale decoder, which specifies the minimum and maximum counts U0 and U1, and the corresponding minimum and maximum output signal S0 and S1 in L/s.</p> <div style="text-align: center;">  <p>PWM 12 bits</p> <p>—————&gt; [ PWM Decoder ] ———&gt; [ Scale ] ———&gt; Qgn in l/s</p> <p>5 - 95% Duty                      205 - 3890 Counts      0 - 20 l/s</p> <p>0% and 100% duty cycle can not be detected.</p> </div>
	DPWM	<p>Two 6-bit PWM signals pass through a DPWM detector that converts it to 0–4095 counts. The DPWM detector sends the 0–4095 counts to the scale decoder, which specifies the minimum and maximum counts U0 and U1, and the corresponding minimum and maximum output signal S0 and S1 in L/s.</p> <div style="text-align: center;">  <p>DPWM</p> <p>PWM 6 bits ———&gt; [ DPWM Detector ] ———&gt; [ Scale ] ———&gt; Qgn in l/s</p> <p>PWM 6 bits ———&gt;                      205 - 3890 Counts      0 - 20 l/s</p> <p>5 - 95% Duty</p> </div>

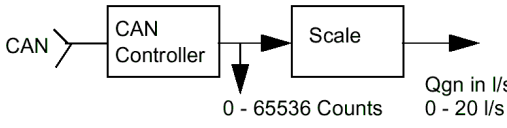
Menu/Window	Parameter	Function																	
Parameters Menu/ Flow Input Window	CAN	<p>The 16 bit CAN signal (11 bit CAN interface CAN 2.0 A) passes through a CAN controller that converts it to 0–65536 counts. The CAN controller sends the 0–65536 counts to the scale decoder, which specifies the minimum and maximum counts U0 and U1, and the corresponding minimum and maximum output signal S0 and S1 in L/s.</p>  <pre> graph LR     CAN((CAN)) --&gt; CC[CAN Controller]     CC -- "0 - 65536 Counts" --&gt; S[Scale]     S -- "Qgn in l/s 0 - 20 l/s" --&gt; Out(( ))             </pre> <p>The message sent will, in general, contain 8 bytes. This is the maximum that can be sent with a single CAN message. All bytes contain data and do not, like some protocols from CAN control, contain one byte for flow control.</p>																	
	CAN & PWM	CAN represents the Qgn scale, and PWM represents the Qgn2 scale. For description of CAN signal and PWM signal, see description PWM and CAN. PWM signal (Qgn2) is a backup signal in case the CAN signal fails.																	
	EGS	Especially for communication with EGS (controls the air/fuel ratio and the speed of gas engines). The scale and filters do not have any effect on this form of communication.																	
Parameters Menu/ Version Info Window	Provides an overview of the TecJet 50 software version, co-processor version, part number, etc.																		
Parameters Menu/ CAN Interface Window	Acceptance Code	Set to = 255.																	
	Acceptance Mask	Set to = 255.																	
	Bus Timing 0	Set to = 1.																	
	Bus Timing 1	Set to = 28.																	
	Receive ID	Normally set to 1024. If the EGS protocol is being used, please refer to the EGS manual for details of the new setting.																	
	Transmit ID	Normally set to 1280. If the EGS protocol is being used, please refer to the EGS manual for details of the new setting.																	
<p><b>Harness Coding</b></p> <p>The Harness Coding will be used if the send and receive IDs in the monitor program are set to "0". The Harness Coding identifies four different TecJet 50 s. For this purpose, there are two pins on the TecJet 50 connector.</p> <table border="1"> <thead> <tr> <th>TecJet 50 No.</th> <th>Switch input#2 (P in H)</th> <th>Switch input#1 (P in C)</th> <th>Comment</th> </tr> </thead> <tbody> <tr> <td>TecJet 50 #1</td> <td>Floating high</td> <td>Floating high</td> <td rowspan="4">Default no connection</td> </tr> <tr> <td>TecJet 50 #2</td> <td>Floating high</td> <td>Pulled low</td> </tr> <tr> <td>TecJet 50 #3</td> <td>Pulled low</td> <td>Floating high</td> </tr> <tr> <td>TecJet 50 #4</td> <td>Pulled low</td> <td>Pulled low</td> </tr> </tbody> </table>			TecJet 50 No.	Switch input#2 (P in H)	Switch input#1 (P in C)	Comment	TecJet 50 #1	Floating high	Floating high	Default no connection	TecJet 50 #2	Floating high	Pulled low	TecJet 50 #3	Pulled low	Floating high	TecJet 50 #4	Pulled low	Pulled low
TecJet 50 No.	Switch input#2 (P in H)	Switch input#1 (P in C)	Comment																
TecJet 50 #1	Floating high	Floating high	Default no connection																
TecJet 50 #2	Floating high	Pulled low																	
TecJet 50 #3	Pulled low	Floating high																	
TecJet 50 #4	Pulled low	Pulled low																	
Diagnostics Menu/ Default Tables Window	Default tables provide you with tables containing pre-adjusted values of Delta P, FGP, and FGT versus Qgn. The information contained in the default tables will be used whenever there is a U-limit High flag or a U-limit Low flag on the "STATUS" menu visible for these parameters.																		
Diagnostics Menu/ Physical Limits Window	Physical limits table provides you with the physical min. value and the max. value of the Delta P, FGP, FGT. If these limits are reached, flags will appear on the "STATUS" menu as a notification to the user.																		
All Parameters Menu/ PC → TecJet 50	Uploading parameters from the PC to the TecJet 50 when the system is in operation.																		
All Parameters Menu/ TecJet 50 ← PC	Downloading parameters from the TecJet 50 in to the PC.																		



Menu/Window	Parameter	Function
Window Menu	Close	If you want to close a window of one of the open menus, select "Close", or press Ctrl and F4 at the same time if you can't use the mouse of your PC.
	Move	If you want to move a window to anywhere on the screen, select "Move, or press Ctrl and F5 at the same time if you can't use the mouse of your PC.
	Next or Previous	If you want to go to the previous or to the next window, select "Next" (Ctrl and F6) or select "Previous" (Ctrl and F7).
	Toggle Screen Res	If you want to display more windows at the same time, select "Toggle Screen Res". With "Toggle Screen Res", you can change the screen's text resolution from 25 rows to 50 rows, and vice versa.
	About	Gives TecJet 50 monitor version/change/engineer information.

## IMPORTANT

See the previous section for a brief overview and visual representation of the software.

## Replacement of TecJet 50 Gas Control Valve

In case of replacement for your TecJet 50 gas control valve, select one of these replace adjustment procedures:

- Programming parameters in the old TecJet 50 are known by the customer and Woodward, and can be copied by Woodward to the new TecJet 50 before installation (see [I] below).
- Programming parameters in the new TecJet 50 are unknown by the customer or Woodward, and have to be copied from the old TecJet 50 to the new TecJet 50 in the field (see [II] below).

### [I] Downloading Parameters from the old TecJet 50 into the new TecJet 50 before Installation

1. Shut down the engine (if possible) according to the engine manufacturer's procedures.
2. Close the manual shut-off valve in the gas stream.
3. Disconnect the electrical connector from the TecJet 50 connector.
4. Remove the TecJet 50 gas control valve.
5. Discard the old sealant material or gasket from the gas pipe.
6. Put a new gasket on both sides of the TecJet 50, and install the new TecJet 50.
7. Check the TecJet 50 connection for gas leakages by opening the manual shut-off valve and the gas shut-off solenoid valve.
8. Connect the electrical connector to the TecJet 50 connector.
9. Open the manual shut-off valve.

**[II] Downloading Parameters from the old TecJet 50 into the new TecJet 50 in the Field**

1. Shut down the engine (if possible) according to the engine manufacturer's procedures.
2. Close the manual shut-off valve in the gas stream.
3. Disconnect the electrical connector from the TecJet 50 connector.
4. Connect a PC laptop computer to the TecJet 50 and start the Tjmon.exe monitor program.
5. Make a note of the following parameters:
  - Qgn control: CAN / PWM single / PWM double / Analog
  - Gas density in  $\text{kg}/\text{nm}^3$
  - Wobbe index in  $\text{MJ}/\text{nm}^3$
  - Physical limits in L/s
  - Default Delta P
6. Remove the old TecJet 50.
7. Discard the old sealant material from the gas pipe.
8. Put a new gasket on both sides of the TecJet 50, and install the new TecJet 50.
9. Check the TecJet 50 connection for gas leakages by opening the manual shut-off valve and the gas shut-off solenoid valve.
10. Connect the electrical connector to the TecJet 50 connector.
11. Open the manual shut-off valve.

**Impossible to Download Parameters from an old TecJet 50 to a new TecJet50**

The customer should keep a paper copy of the TecJet 50 set-up, so that all parameters can be manually entered if necessary.

# Chapter 4.

## Troubleshooting

### Introduction

The TecJet™ 50 contains an extensive range of diagnostic capabilities. The overall running condition of the TecJet 50 can be seen using the View menu/Status window (see Chapter 3).

In general, if the “Overall status OK” flag is not set (not crossed), this indicates that there is a problem with the TecJet 50 or its associated systems. A history of problems experienced can be viewed using the View/Error Log menu. Use the error log codes table in this chapter for further details of your specific error code.

In addition to the error log, messages that report problems are also visible on the screen connected to your TecJet 50.

### Error Codes

Error Code	Meaning	Description
65	RAM Failure	External RAM is not functioning during start-up. <ul style="list-style-type: none"> <li>Please return your TecJet 50 to Woodward.</li> </ul>
66	Failure Co-processor	Co-processor is not functioning during start-up. <ul style="list-style-type: none"> <li>Please return your TecJet 50 to Woodward.</li> </ul>
67	Co-processor Version	Co-processor has an incorrect version during start-up or after resetting the co-processor. <ul style="list-style-type: none"> <li>Please return your TecJet 50 to Woodward.</li> </ul>
4	Co-processor ADC Failure	The ADC conversion in the co-processor is not working. <ul style="list-style-type: none"> <li>Please return your TecJet 50 to Woodward.</li> </ul>
69	ADC Failure	The ADC converter, located in the main processor, is not working. <ul style="list-style-type: none"> <li>Please return your TecJet 50 to Woodward.</li> </ul>
70	ADC Reference	The reference voltage of the ADC converter is low. <ul style="list-style-type: none"> <li>Please return your TecJet 50 to Woodward.</li> </ul>
71	CAN Controller Re-set	The CAN controller cannot be found and configured. <ul style="list-style-type: none"> <li>Please return your TecJet 50 to Woodward.</li> </ul>
72	CAN Controller Databus	The CAN controller cannot be found and configured. <ul style="list-style-type: none"> <li>Please return your TecJet 50 to Woodward.</li> </ul>
9	CAN Controller Re-start	An error-interrupt from the CAN controller was seen. The CAN controller will be restarted. Communications will stop during this process. <ul style="list-style-type: none"> <li>Check CAN wiring and termination resistors.</li> </ul>

Error Code	Meaning	Description
10	CAN ID Unstable	The address from the harness code is unstable. <ul style="list-style-type: none"> <li>Check harness coding and wiring.</li> </ul>
11	Valve Calibration	Before the calibrated values are stored in parameters, the position sensors are checked, based on range (this is a Woodward production item).
12	Battery Voltage too low to Perform Calibration	The battery voltage will be checked before calibration (this is a Woodward production item).
77	No Position Sensor Calibration Performed	On the calibration parameters, a crc16 check has failed (this is a Woodward production item).
14	Software Timeout Detected	Not used.
15	Detected PCB Type Unknown	Checks for the type of PCB for sensor diagnostic. It will read to see if there is a FGP or dP active sensor. It will also check if the PWM frequency is set (this is a Woodward production item).
80	Out of PWM Frequency Range	During run-time, the PWM frequency will be checked. <ul style="list-style-type: none"> <li>Check frequently.</li> </ul>
81	Out of PWM Frequency Range	During run-time the PWM frequency will be checked. <ul style="list-style-type: none"> <li>Check frequently.</li> </ul>
103	Position Sensors 1 & 2	Use Woodward guidelines for cleaning the sensors.
30	Position Sensor 1	Running on sensor 2. <ul style="list-style-type: none"> <li>Clean sensor 1.</li> </ul>
31	Position Sensor 2	Running on sensor 1. <ul style="list-style-type: none"> <li>Clean sensor 2.</li> </ul>
32	Qgn Input Limit Error	Qgn setpoint is out of range (U-limit). <ul style="list-style-type: none"> <li>Check wiring.</li> </ul>
33	Icoil Input Circuit	Coil is drawing too much current. <ul style="list-style-type: none"> <li>Inspect engine for "sticky" pistons.</li> </ul>
34	Absolute Pressure Sensor (FGP)	Gas pressure is out of range (U-limit). <ul style="list-style-type: none"> <li>Check inlet gas pressure and gas filter.</li> </ul>
35	Delta Pressure Sensor (dP)	dP is out of range (U-limit). <ul style="list-style-type: none"> <li>Check dP over TecJet 50.</li> <li>Check for a blockage in the outlet.</li> <li>Check filter.</li> </ul>
36	Gas Temperature Sensor (FGT)	Temperature of gas is out of range (U-limit). <ul style="list-style-type: none"> <li>Check the operational temperature of gas flow.</li> </ul>
37	Electronic Temperature Sensor	Reserved. <ul style="list-style-type: none"> <li>No action.</li> </ul>

## Messages

System Status	Related Error Description	Actions
"TecJet 50 Bad"	65 or RAM failure. 6 or Failure co-processor. 67 or co-processor version. 69 or ADC failure. 70 or ADC reference. 71 or CAN controller re-set. 72 or CAN controller databus. 15 or Detected PCB type unknown. Please note that the above error will cause the message "TecJet 50 Bad" to appear on the screen. See Chapter 3 for further details of the error messages.	
"Status Bar"	RUN: This will appear when the TecJet 50 is communication with the TJMON software. The back-slash character rotates when communication is OK.	<ul style="list-style-type: none"> <li>• Check wiring.</li> <li>• Check ignition input is active.</li> <li>• Check service input is not active.</li> </ul>
	COM LOST: This message will appear if communications between the TecJet 50 and the TJMON software have been lost.	<ul style="list-style-type: none"> <li>• Check wiring.</li> <li>• Check ignition input is active.</li> <li>• Check service input is not active.</li> </ul>

# Chapter 5.

## Technical Specifications

### TecJet™ 50 Specifications

Weight	14.5 kg (32.0 lb)
Power Supply Rating	18–32 Vdc
Power Consumption	15 W and 40 W peak
Ambient Temperature	–25 to + 85 °C (–13 to +185 °F)
Storage Temperature	–40 to + 105 °C (–40 to +221 °F)
Pressure Range:	
Low Pressure TecJet	Up to 150 mbar with a measuring range of 180 mbar
High Pressure TecJet	Up to 450 mbar with a measuring range of 500 mbar
Flow Capacity	See next section
Accuracy	Dependent upon gas pressure $2 < P < 15\%$
Response Time	< 80 ms (10–90% opening, @24 V)
Resolution	[See Chapter 3, Parameters Menu/Flow Input Window]
Vibration, Swept Sine	5 G, 2.5 mm, 5–2000 Hz, 3 h min/axis, 90 min dwells
Vibration, Random	0.1 G <sup>2</sup> /Hz, 10–2000 Hz, 3 h/axis, 12.8 Grms
Shock	40 G, 11 ms sawtooth pulse
Input Signal (flow request)	CAN 5 V, CAN 24 V Analog 0–5 Vdc (impedance 40 kΩ) * PWM 12 bit resolution (impedance 3 kΩ) ** Double PWM 6-bit resolution *
	* 0–100% flow = 0.2–4.8 Vdc (other values programmable) ** 0–100% flow = 5–95% duty (other values programmable) has to be connected to open collector output frequency: min. 75 Hz / nom. 128 Hz / max. 150 Hz
EMC (Electromagnetic Compatibility)	EN 61000-6-2 (Immunity) EN 61000-6-4 (Emissions) [See Chapter 2, Electromagnetic Compatibility] Alternator load dump, ISO 7637-2, Test pulse 5, Ip = 8 A, Rs = 3 Ω ISO 11452-2, 100 V/m, Class A, Region 1
Gas Filter in the Gas Flow	Maximum mesh size 50 μm

## TecJet 50 Flow Capacity

The following graphs are based on the density of the gas at 0.82 kg/m<sup>3</sup>.

Please use the following equations to modify the graphs to your requirements:

Using the example of landfill gas (60% CH<sub>4</sub> and 40% CO<sub>2</sub>)

Density = 1.221 kg/nm<sup>3</sup>

Gas temperature = 50 °C (max. = 65 °C)

Gas flow = 450 nm<sup>3</sup>/h

To correct the density and/or temperature:

Density = 1.221 \* (273/(273+Tgas)) = 1.03 nm<sup>3</sup>/h

Flow = 450 \* 1.221/1.03 = 532 nm<sup>3</sup>/h

Flow (at 0.82) = 532 \* SQR(1.03/0.82) = 596 nm<sup>3</sup>/h

Maximum differential pressure (DP): 40 kPa

Minimum differential pressure: 3 kPa

Maximum absolute gas pressure (AP): 250 kPa

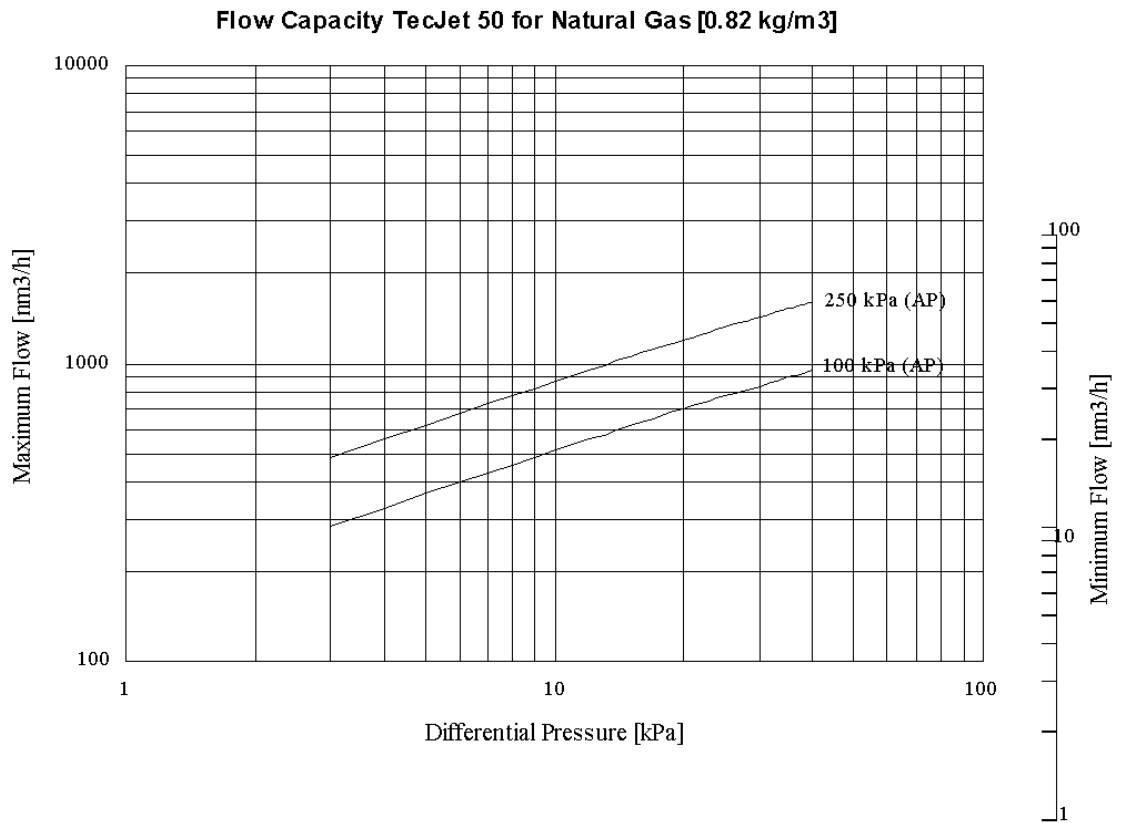

Figure 5-1. Flow Capacity for the TecJet 50, Version 1

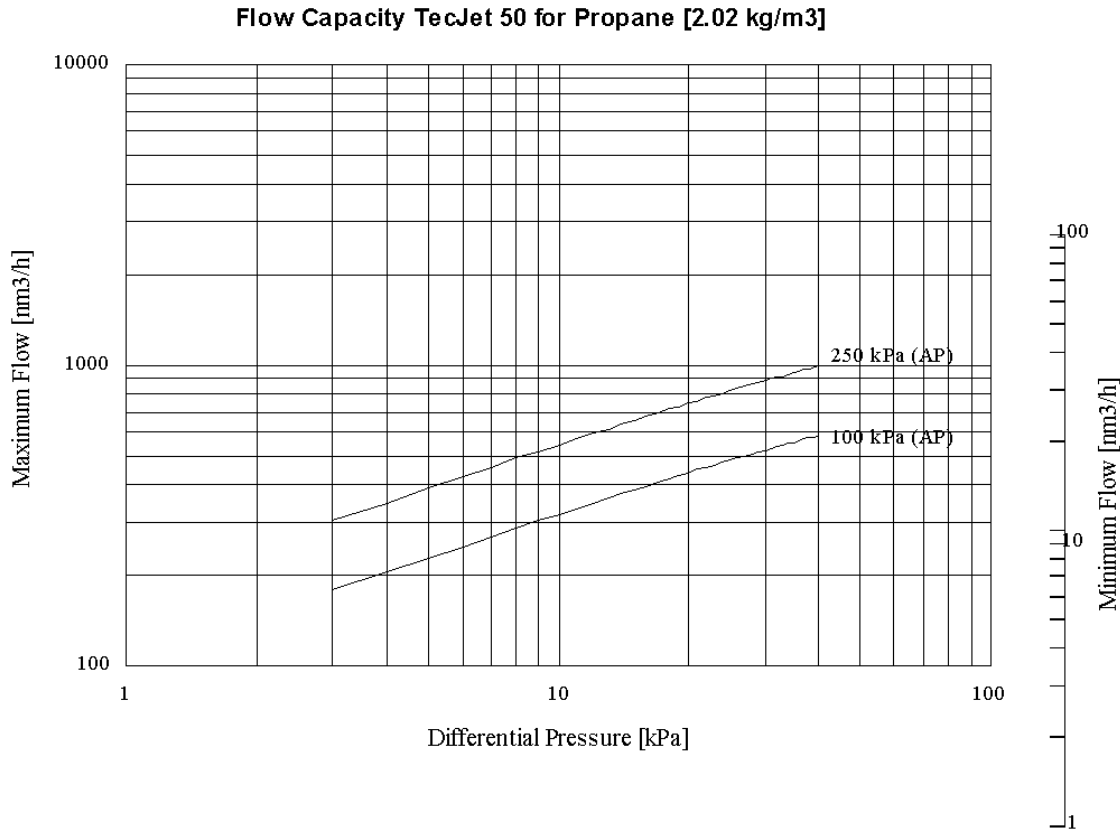

Figure 5-2. Flow Capacity for the TecJet 50, Version 2

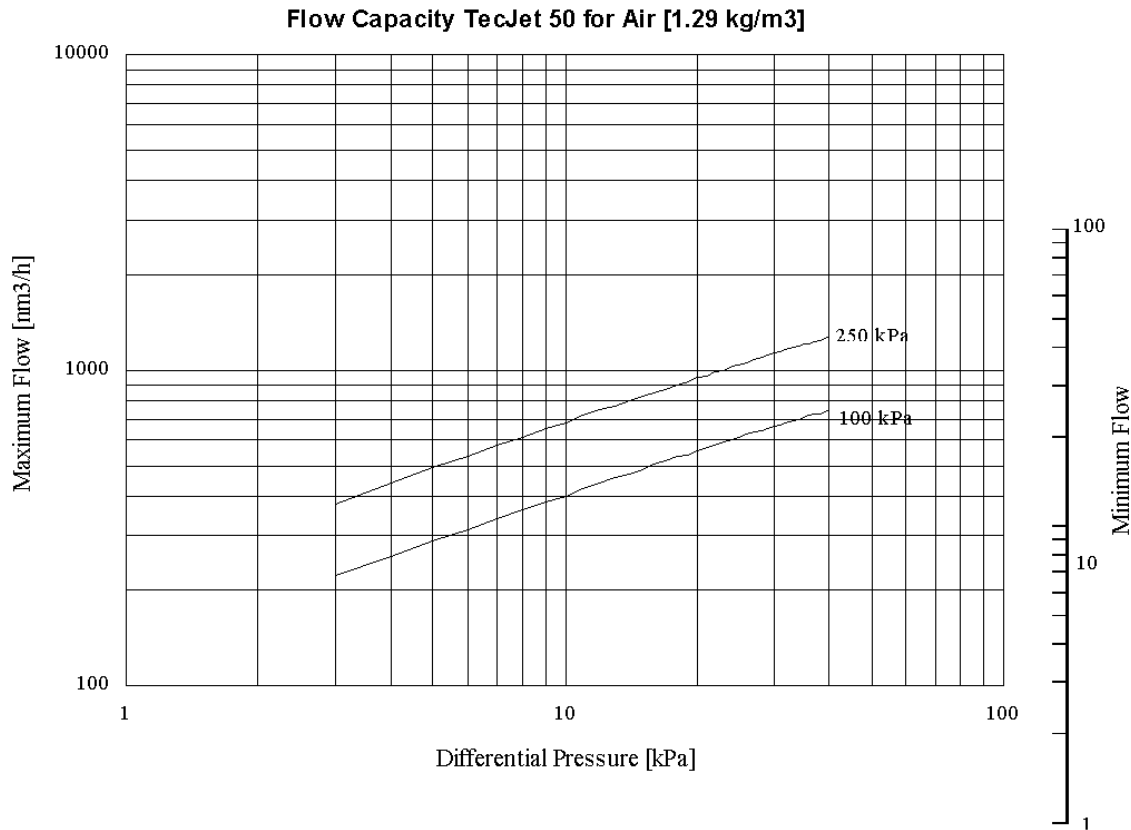

Figure 5-3. Flow Capacity for the TecJet 50, Version 3



# Chapter 6.

## Service Options

### Product Service Options

If you are experiencing problems with the installation, or unsatisfactory performance of a Woodward product, the following options are available:

- Consult the troubleshooting guide in the manual.
- Contact the manufacturer or packager of your system.
- Contact the Woodward Full Service Distributor serving your area.
- Contact Woodward technical assistance (see “How to Contact Woodward” later in this chapter) and discuss your problem. In many cases, your problem can be resolved over the phone. If not, you can select which course of action to pursue based on the available services listed in this chapter.

**OEM and Packager Support:** Many Woodward controls and control devices are installed into the equipment system and programmed by an Original Equipment Manufacturer (OEM) or Equipment Packager at their factory. In some cases, the programming is password-protected by the OEM or packager, and they are the best source for product service and support. Warranty service for Woodward products shipped with an equipment system should also be handled through the OEM or Packager. Please review your equipment system documentation for details.

**Woodward Business Partner Support:** Woodward works with and supports a global network of independent business partners whose mission is to serve the users of Woodward controls, as described here:

- A **Full Service Distributor** has the primary responsibility for sales, service, system integration solutions, technical desk support, and aftermarket marketing of standard Woodward products within a specific geographic area and market segment.
- An **Authorized Independent Service Facility (AISF)** provides authorized service that includes repairs, repair parts, and warranty service on Woodward's behalf. Service (not new unit sales) is an AISF's primary mission.
- A **Recognized Engine Retrofitter (RER)** is an independent company that does retrofits and upgrades on reciprocating gas engines and dual-fuel conversions, and can provide the full line of Woodward systems and components for the retrofits and overhauls, emission compliance upgrades, long term service contracts, emergency repairs, etc.
- A **Recognized Turbine Retrofitter (RTR)** is an independent company that does both steam and gas turbine control retrofits and upgrades globally, and can provide the full line of Woodward systems and components for the retrofits and overhauls, long term service contracts, emergency repairs, etc.

A current list of Woodward Business Partners is available at [www.woodward.com/support](http://www.woodward.com/support).

## Woodward Factory Servicing Options

The following factory options for servicing Woodward products are available through your local Full-Service Distributor or the OEM or Packager of the equipment system, based on the standard Woodward Product and Service Warranty (5-01-1205) that is in effect at the time the product is originally shipped from Woodward or a service is performed:

- Replacement/Exchange (24-hour service)
- Flat Rate Repair
- Flat Rate Remanufacture

**Replacement/Exchange:** Replacement/Exchange is a premium program designed for the user who is in need of immediate service. It allows you to request and receive a like-new replacement unit in minimum time (usually within 24 hours of the request), providing a suitable unit is available at the time of the request, thereby minimizing costly downtime. This is a flat-rate program and includes the full standard Woodward product warranty (Woodward Product and Service Warranty 5-01-1205).

This option allows you to call your Full-Service Distributor in the event of an unexpected outage, or in advance of a scheduled outage, to request a replacement control unit. If the unit is available at the time of the call, it can usually be shipped out within 24 hours. You replace your field control unit with the like-new replacement and return the field unit to the Full-Service Distributor.

Charges for the Replacement/Exchange service are based on a flat rate plus shipping expenses. You are invoiced the flat rate replacement/exchange charge plus a core charge at the time the replacement unit is shipped. If the core (field unit) is returned within 60 days, a credit for the core charge will be issued.

**Flat Rate Repair:** Flat Rate Repair is available for the majority of standard products in the field. This program offers you repair service for your products with the advantage of knowing in advance what the cost will be. All repair work carries the standard Woodward service warranty (Woodward Product and Service Warranty 5-01-1205) on replaced parts and labor.

**Flat Rate Remanufacture:** Flat Rate Remanufacture is very similar to the Flat Rate Repair option with the exception that the unit will be returned to you in “like-new” condition and carry with it the full standard Woodward product warranty (Woodward Product and Service Warranty 5-01-1205). This option is applicable to mechanical products only.

## Returning Equipment for Repair

If a control (or any part of an electronic control) is to be returned for repair, please contact your Full-Service Distributor in advance to obtain Return Authorization and shipping instructions.

When shipping the item(s), attach a tag with the following information:

- return number;
- name and location where the control is installed;
- name and phone number of contact person;
- complete Woodward part number(s) and serial number(s);
- description of the problem;
- instructions describing the desired type of repair.

## Packing a Control

Use the following materials when returning a complete control:

- protective caps on any connectors;
- antistatic protective bags on all electronic modules;
- packing materials that will not damage the surface of the unit;
- at least 100 mm (4 inches) of tightly packed, industry-approved packing material;
- a packing carton with double walls;
- a strong tape around the outside of the carton for increased strength.

### **NOTICE**

To prevent damage to electronic components caused by improper handling, read and observe the precautions in Woodward manual 82715, *Guide for Handling and Protection of Electronic Controls, Printed Circuit Boards, and Modules*.

## Replacement Parts

When ordering replacement parts for controls, include the following information:

- the part number(s) (XXXX-XXXX) that is on the enclosure nameplate;
- the unit serial number, which is also on the nameplate.

## Engineering Services

Woodward offers various Engineering Services for our products. For these services, you can contact us by telephone, by email, or through the Woodward website.

- Technical Support
- Product Training
- Field Service

**Technical Support** is available from your equipment system supplier, your local Full-Service Distributor, or from many of Woodward's worldwide locations, depending upon the product and application. This service can assist you with technical questions or problem solving during the normal business hours of the Woodward location you contact. Emergency assistance is also available during non-business hours by phoning Woodward and stating the urgency of your problem.

**Product Training** is available as standard classes at many of our worldwide locations. We also offer customized classes, which can be tailored to your needs and can be held at one of our locations or at your site. This training, conducted by experienced personnel, will assure that you will be able to maintain system reliability and availability.

**Field Service** engineering on-site support is available, depending on the product and location, from many of our worldwide locations or from one of our Full-Service Distributors. The field engineers are experienced both on Woodward products as well as on much of the non-Woodward equipment with which our products interface.

For information on these services, please contact us via telephone, email us, or use our website and reference [www.woodward.com/support](http://www.woodward.com/support), and then **Customer Support**.

## How to Contact Woodward

For assistance, call one of the following Woodward facilities to obtain the address and phone number of the facility nearest your location where you will be able to get information and service.

<b>Electrical Power Systems</b>	
<b>Facility</b> -----	<b>Phone Number</b>
Australia-----	+61 (2) 9758 2322
Brazil-----	+55 (19) 3708 4800
China-----	+86 (512) 6762 6727
Germany:	
Kempen ---	+49 (0) 21 52 14 51
Stuttgart ----	+49 (711) 78954-0
India-----	+91 (129) 4097100
Japan-----	+81 (43) 213-2191
Korea-----	+82 (51) 636-7080
Poland-----	+48 12 618 92 00
United States-----	+1 (970) 482-5811

<b>Engine Systems</b>	
<b>Facility</b> -----	<b>Phone Number</b>
Australia-----	+61 (2) 9758 2322
Brazil-----	+55 (19) 3708 4800
China-----	+86 (512) 6762 6727
Germany:	
Stuttgart ----	+49 (711) 78954-0
India-----	+91 (129) 4097100
Japan-----	+81 (43) 213-2191
Korea-----	+82 (51) 636-7080
The Netherlands -	+31 (23) 5661111
United States-----	+1 (970) 482-5811

<b>Turbine Systems</b>	
<b>Facility</b> -----	<b>Phone Number</b>
Australia-----	+61 (2) 9758 2322
Brazil-----	+55 (19) 3708 4800
China-----	+86 (512) 6762 6727
India-----	+91 (129) 4097100
Japan-----	+81 (43) 213-2191
Korea-----	+82 (51) 636-7080
The Netherlands -	+31 (23) 5661111
United States-----	+1 (970) 482-5811

You can also contact the Woodward Customer Service Department or consult our worldwide directory on Woodward's website ([www.woodward.com/support](http://www.woodward.com/support)) for the name of your nearest Woodward distributor or service facility.

For the most current product support and contact information, please refer to the latest version of publication **51337** at [www.woodward.com/publications](http://www.woodward.com/publications).

## Technical Assistance

If you need to telephone for technical assistance, you will need to provide the following information. Please write it down here before phoning:

### General

Your Name \_\_\_\_\_  
Site Location \_\_\_\_\_  
Phone Number \_\_\_\_\_  
Fax Number \_\_\_\_\_

### Prime Mover Information

Engine/Turbine Model Number \_\_\_\_\_  
Manufacturer \_\_\_\_\_  
Number of Cylinders (if applicable) \_\_\_\_\_  
Type of Fuel (gas, gaseous, steam, etc) \_\_\_\_\_  
Rating \_\_\_\_\_  
Application \_\_\_\_\_

### Control/Governor Information

Please list all Woodward governors, actuators, and electronic controls in your system:

Woodward Part Number and Revision Letter \_\_\_\_\_  
Control Description or Governor Type \_\_\_\_\_  
Serial Number \_\_\_\_\_

Woodward Part Number and Revision Letter \_\_\_\_\_  
Control Description or Governor Type \_\_\_\_\_  
Serial Number \_\_\_\_\_

Woodward Part Number and Revision Letter \_\_\_\_\_  
Control Description or Governor Type \_\_\_\_\_  
Serial Number \_\_\_\_\_

*If you have an electronic or programmable control, please have the adjustment setting positions or the menu settings written down and with you at the time of the call.*



# Declaration of Incorporation

Woodward Governor Company  
1000 E. Drake Road  
Fort Collins, Colorado 80525  
United States of America

**Product: TecJet 50**  
**Part Number: Includes the Product Family of Part Numbers**

The undersigned hereby declares, on behalf of Woodward Governor Company of Loveland and Fort Collins, Colorado, that the above-referenced product is in conformity with the following EU Directives as they apply to a component:

**98/37/EEC (Machinery)**

This product is intended to be put into service only upon incorporation into an apparatus/system that itself will meet the requirements of the above Directives and bears the CE mark.

**Manufacturer**



Signature

Douglas W. Salter

Full Name

Engineering Manager

Position

WGC, Fort Collins, CO, USA

Location

11/27/02

Date

We appreciate your comments about the content of our publications.

Send comments to: [icinfo@woodward.com](mailto:icinfo@woodward.com)

Please reference publication **36102B**.



PO Box 1519, Fort Collins CO 80522-1519, USA  
1000 East Drake Road, Fort Collins CO 80525, USA  
Phone +1 (970) 482-5811 • Fax +1 (970) 498-3058

Email and Website—[www.woodward.com](http://www.woodward.com)

Woodward has company-owned plants, subsidiaries, and branches,  
as well as authorized distributors and other authorized service and sales facilities throughout the world.

Complete address / phone / fax / email information for all locations is available on our website.